



Gandelin  
TEKNI-LED



L'histoire continue de briller...  
*The story continues to shine...*

# Une lumiere d'avance...

A light ahead...

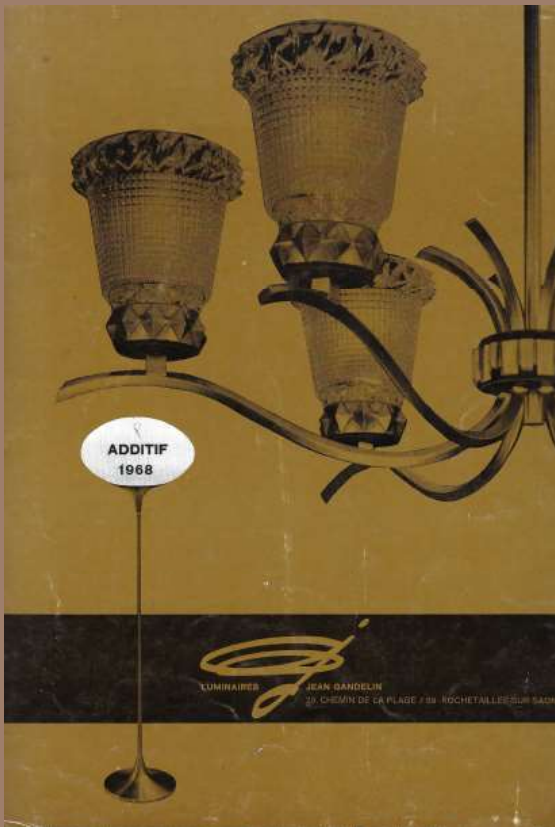

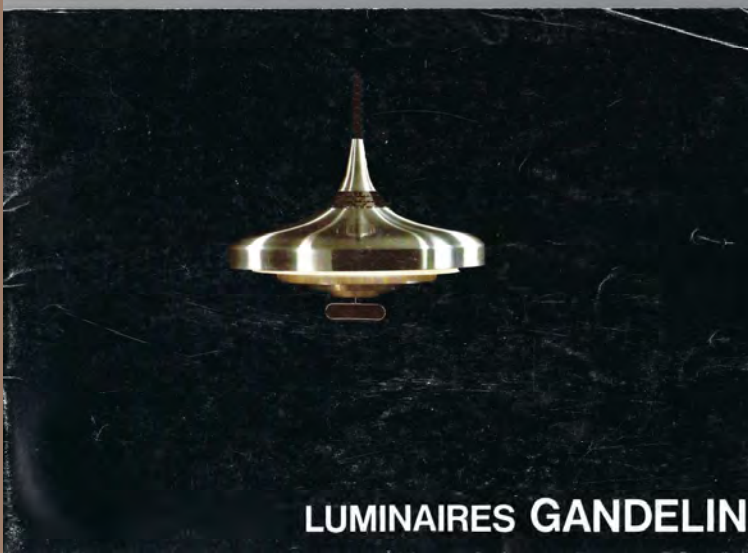

... Depuis 1954  
... Since 1954

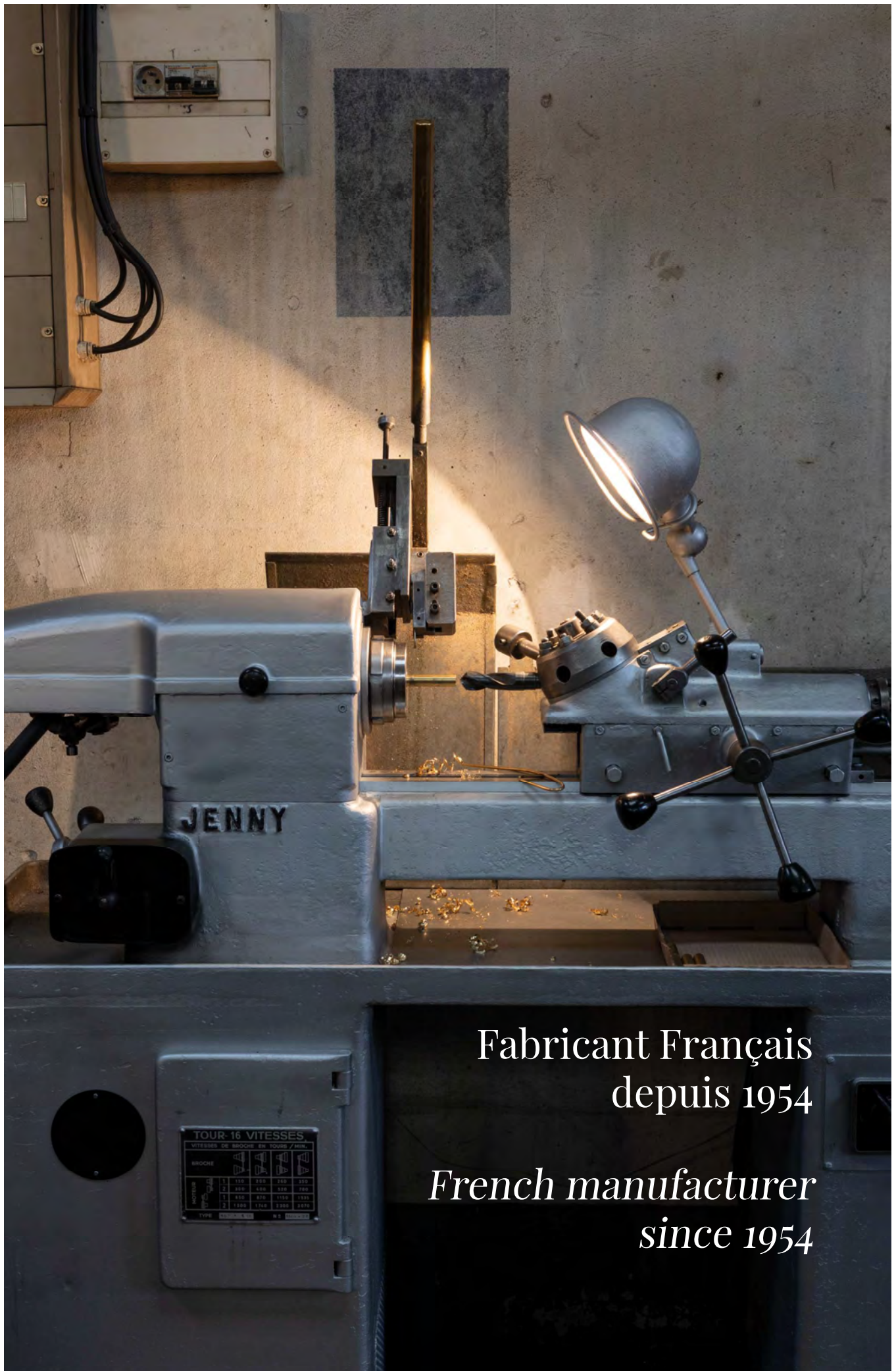

Fabricant Français  
depuis 1954

*French manufacturer  
since 1954*

TOUR 16 VITESSES					
VITESSES DE BROCHE EN TOURS / MIN.					
BROCHE	1	2	3	4	5
1	110	220	330	440	550
2	220	440	660	880	1100
3	330	660	990	1320	1650
4	440	880	1320	1760	2200
5	550	1100	1650	2200	2750

**1954**



Création de  
l'entreprise  
Gandelin par  
Jean Gandelin.

*Establishment  
of Gandelin by  
Jean Gandelin.*



**1982**

Reprise de  
l'entreprise  
Gandelin par  
Gérard Vigne.

*Gérard Vigne  
acquires the  
Gandelin  
company.*

**TEKNI-LED**  
by GANDELIN

**2005**

Changement de nom de  
Gandelin en Tekni-led,  
après la succession à  
Cédric Vigne.

*Name change from  
Gandelin to Tekni-led,  
following succession to  
Cédric Vigne.*



**2026**

Retour sous  
le nom de  
Gandelin.

*Return under  
the name of  
Gandelin.*







p.118

p.119







Chez Gandelin, la lumière renaît entre les mains de nos artisans. Chaque pièce raconte une histoire faite de gestes précis, de matières nobles et d'un savoir-faire transmis avec passion.

Redécouvrez l'éclat d'une lumière façonnée à la main, pensée pour sublimer vos intérieurs avec élégance et authenticité.

*At Gandelin, light reborn in the hands of our artisans. Each piece tells a story craft from precise movements, noble materials and know how passed down with passion.*

*Rediscover the brilliance of handcrafted light, designed to enhance your interiors with elegance and authenticity.*



Nous avons illuminés les plus grands évènements...



Restaurant Paul BOCUSE

...Et les plus belles adresses

Après des années de silence, notre maison rallume sa flamme.

Fidèles à notre héritage, nous perpétons l'art du luminaire français, un art où la finesse du détail, la pureté des formes et la noblesse des matériaux s'unissent pour créer la lumière juste.

Notre renaissance est un hommage à la beauté du fait main et à l'élégance intemporelle.

*After years of silence, our company is reigniting its flame.*

*True to our heritage, we are perpetuate the art of French lighting design, an art in which fine detail, pure forms and noble materials come together to create just the right light.*

*Our rebirth is a tribute to the beauty of handcrafted items and timeless elegance.*



## Une Maîtrise Totale de la Chaîne de Production

Au coeur de nos ateliers, la passion et l'exigence guident chaque geste. Nous avons fait le choix stratégique de conserver l'intégralité de notre fabrication en interne. De la sélection rigoureuse des matériaux jusqu'aux finitions les plus soignées, nous contrôlons chaque étape sans intermédiaire. Ce savoir-faire artisanal, nourri de la technicité moderne, est pour vous le gage d'une qualité irréprochable et d'une durabilité éprouvée.

## La Liberté du Sur-Mesure

Notre autonomie industrielle nous offre une liberté précieuse : celle de ne jamais figer notre offre. Parce que nous concevons ce que nous fabriquons, nous avons la capacité d'adapter nos créations ou de développer du surmesure pour répondre à vos besoins spécifiques. Quelle que soit l'envergure de votre projet, nous apportons une réponse juste et personnalisée.

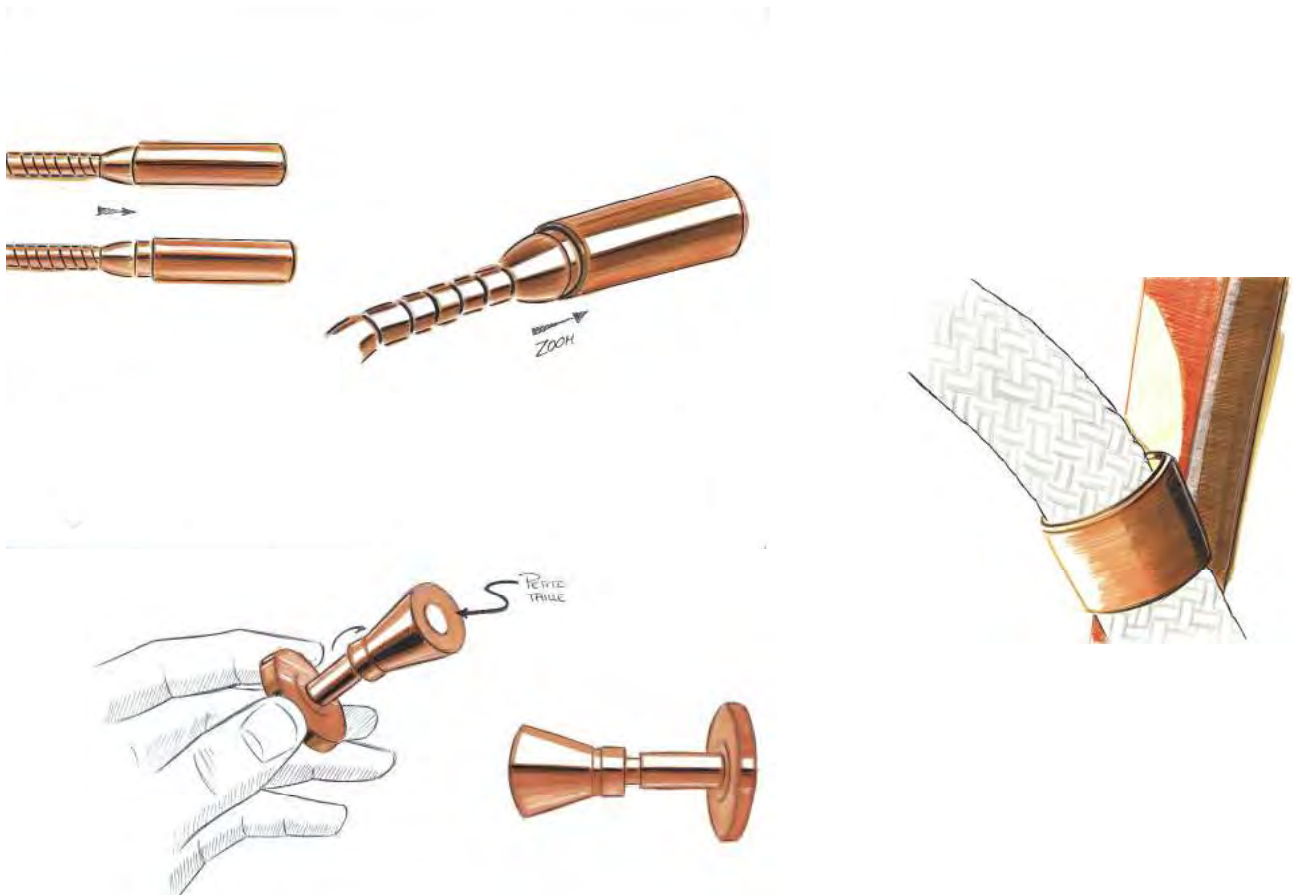

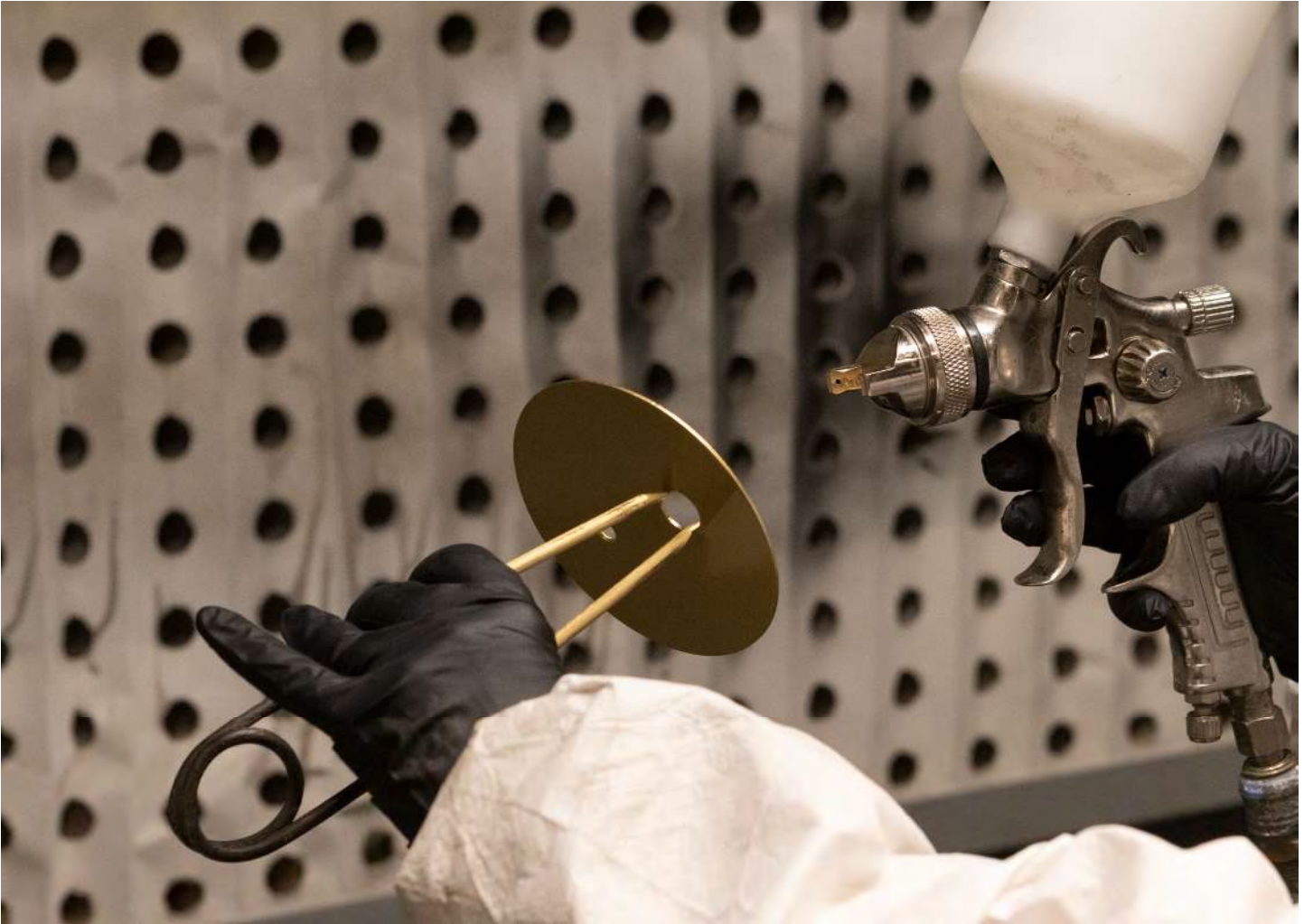

### *Total Mastery of the Production Line*

*At the heart of our workshops, passion and high standards guide every step of the process. We have made the strategic choice to keep all of our manufacturing in-house. From the rigorous selection of materials to the most meticulous finishes, we control every step without intermediaries. This artisanal expertise, enhanced by modern technology, guarantees you impeccable quality and certified durability.*

### *The Freedom of Bespoke*

*Our industrial autonomy gives us valuable freedom: the freedom to never let our offering become static. Because we design what we manufacture, we have the ability to adapt our creations or develop bespoke solutions to meet your specific needs. Whatever the scale of your project, we provide the right, personalised solution.*



# Nos Finitions

Our Finishes



OR  
Laiton poli  
Polished brass



LT  
Laiton brossé vernis satin  
Brushed brass with satin varnish



LTM  
Laiton brossé vernis mat  
Brushed brass with mat varnish



LP  
Laiton patiné vernis satin  
Patinated brass with satin varnish



LPM  
Laiton patiné vernis mat  
Patinated brass with mat varnish

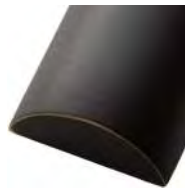

PM  
Patiné mat  
Matte patina



NK  
Nickel mat  
Matte nickel



CH  
Chrome  
Chromium



NS  
Noir structuré  
Textured black



BS  
Blanc structuré  
Textured white



RAL sur demande  
RAL on request



# Sommaire

## Summary

Appliques Liseuses Reading lamp	p.23
Spots Projecteurs Spotlight	p.65
Appliques Murales Wall Lamp	p.72
Appliques Tableaux Wall Picture Lamps	p.80
Spots à poser Table Spotlight	p.102
Lampes & Lampadaires Lamps & Floor Lamps	p.110
Lustre Chandelier	p.124
Semi-encastrés & Encastrés Semi-recessed & Recessed spot	p.126

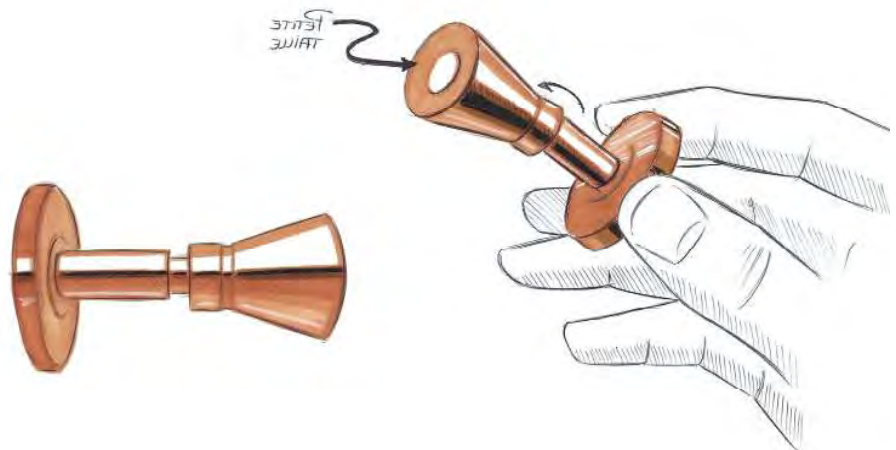

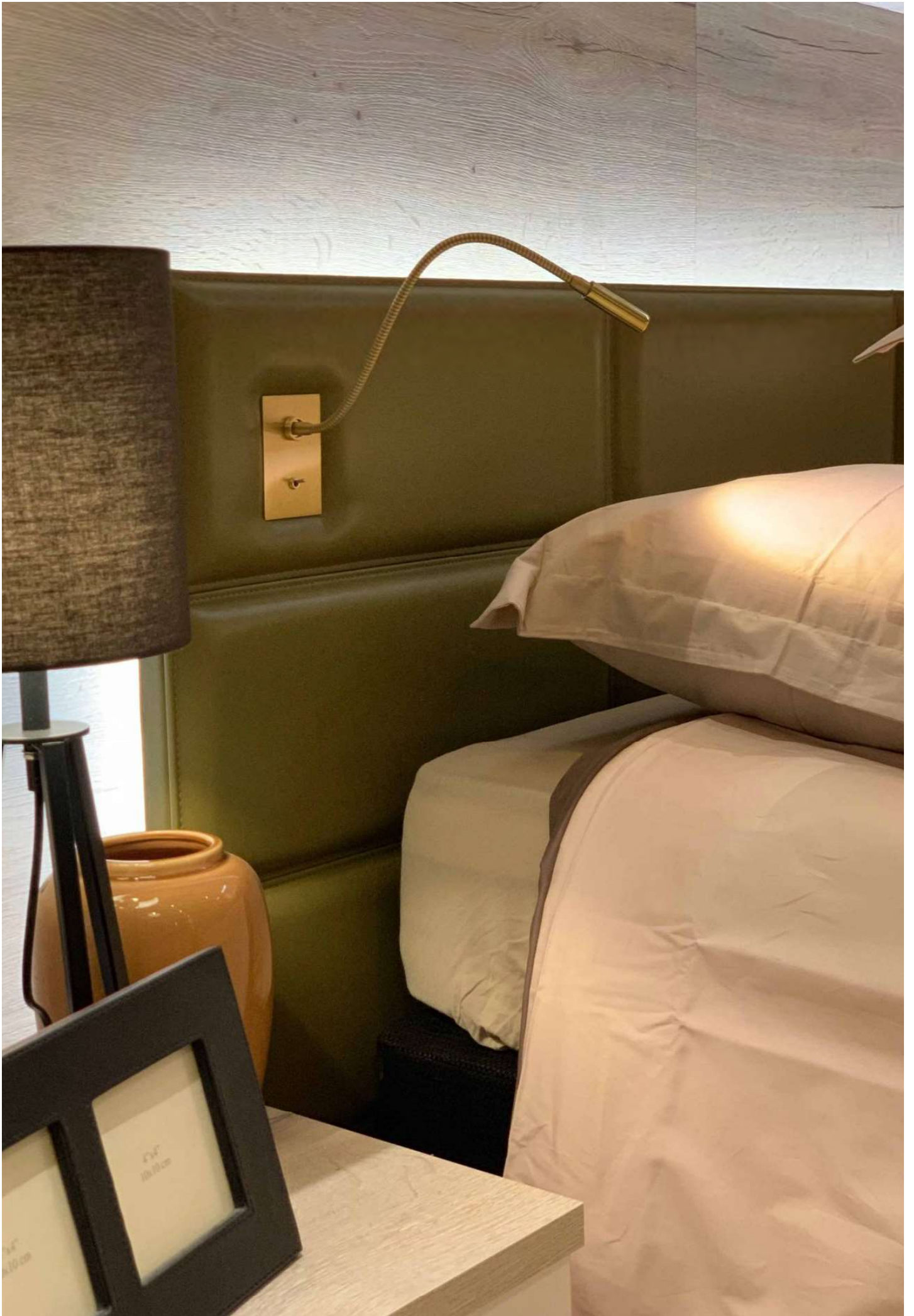





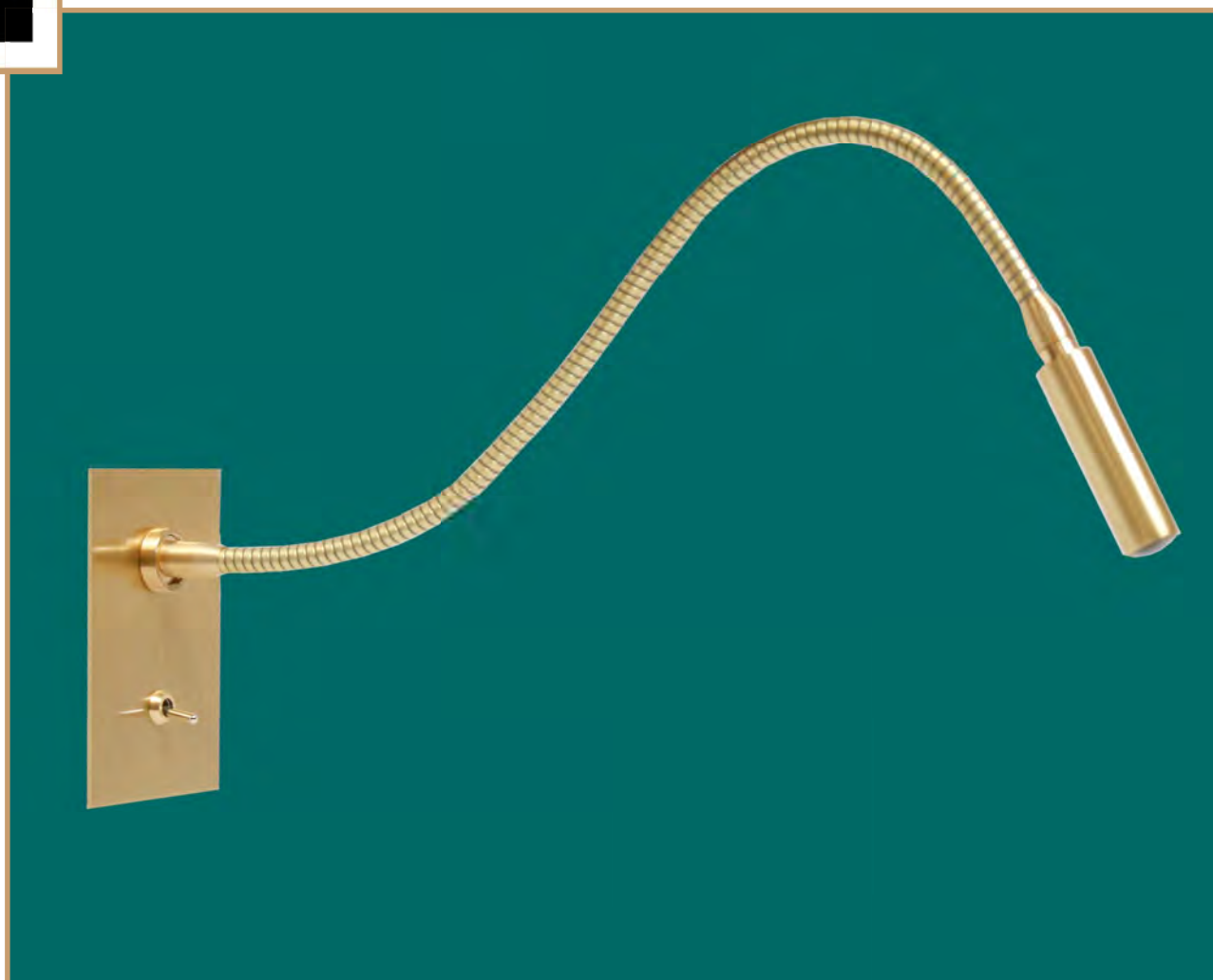

Liseuse  
Reading lamp

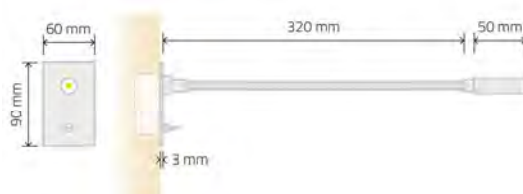

details

## W47 31

1W, 130 lumens, 2700K, CRI>90,  
Optique ajustable 8 à 60°

Finitions disponibles / Available finishes

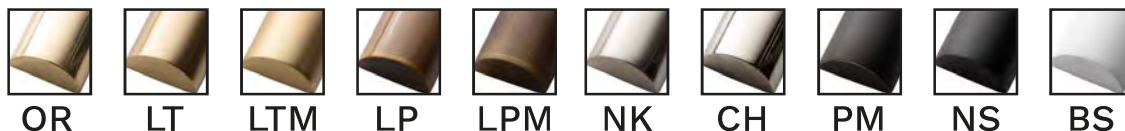

OR

LT

LTM

LP

LPM

NK

CH

PM

NS

BS

# COLLECTION ZOOM

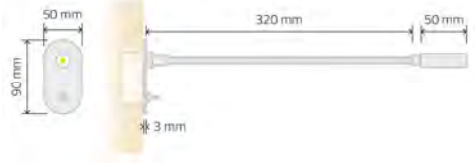
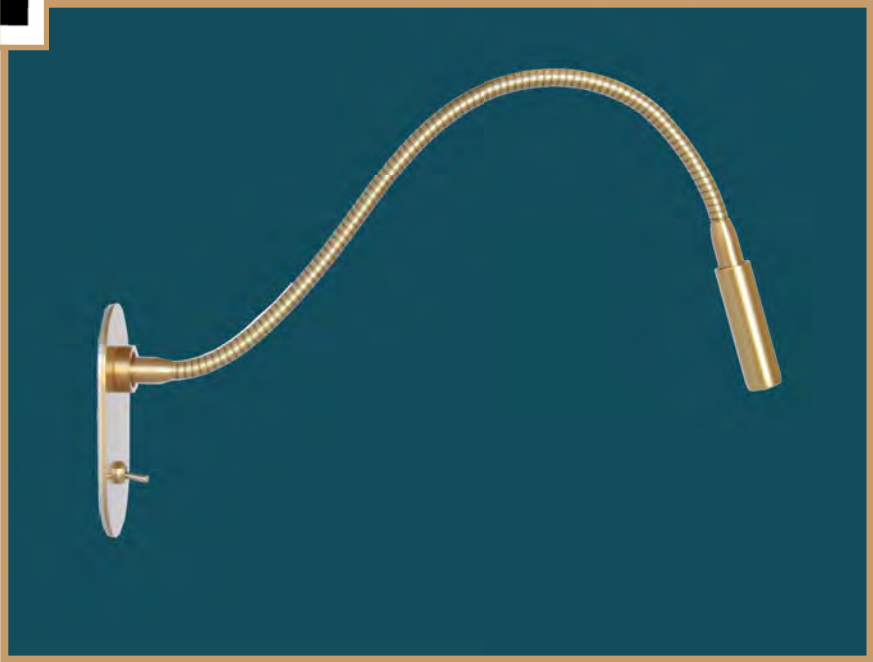

Liseuse  
Reading lamp

**W47 39**

1W, 130 lumens, 2700K, CRI>90, Optique ajustable 8 à 60°

Finitions disponibles / Available finishes

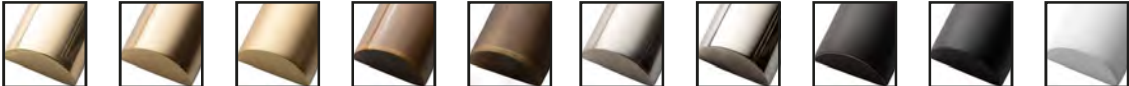

OR

LT

LTM

LP

LPM

NK

CH

PM

NS

BS

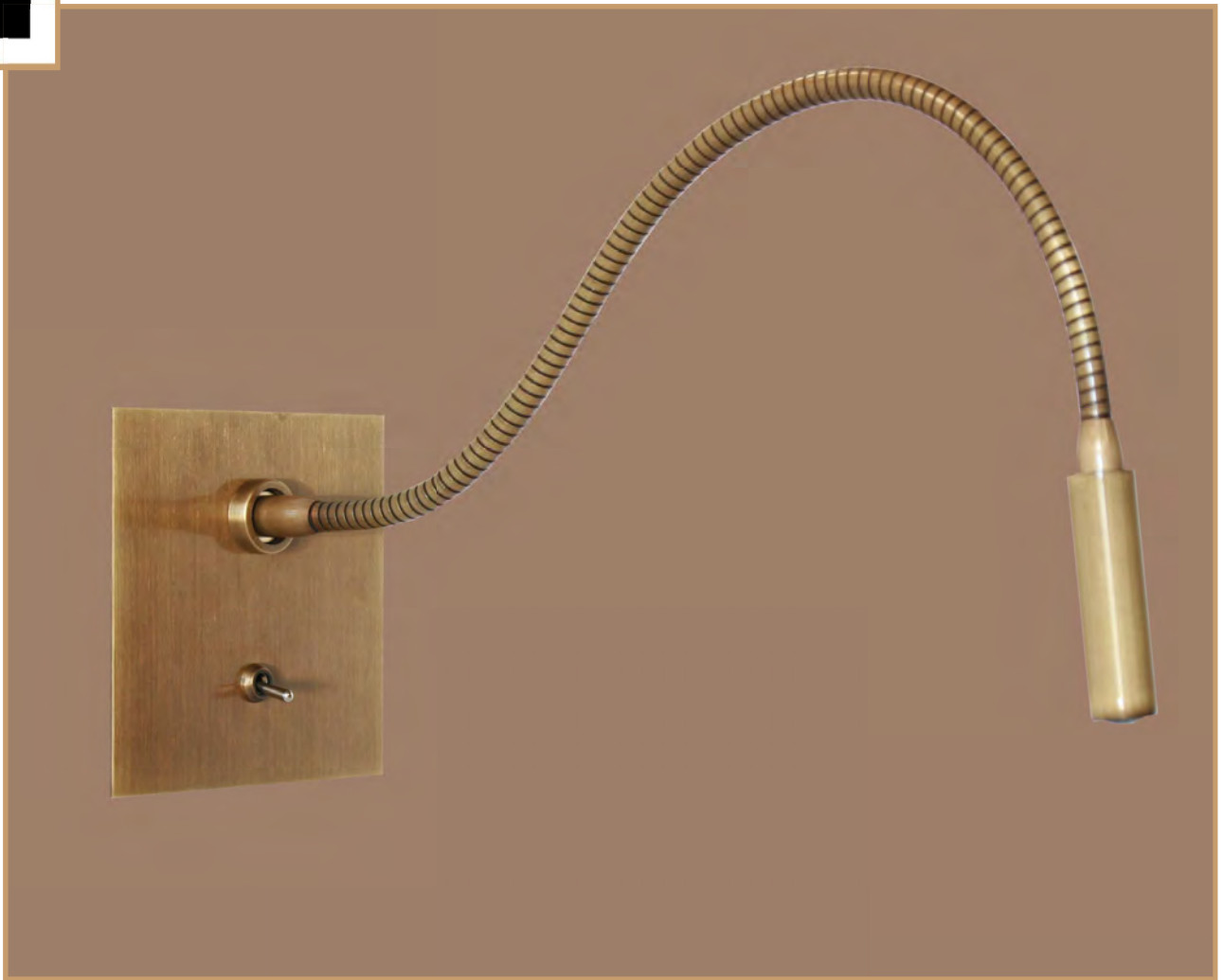

## Liseuse Reading lamp

### W47 33

1W, 130 lumens, 2700K, CRI>90,  
Optique ajustable 8 à 60°

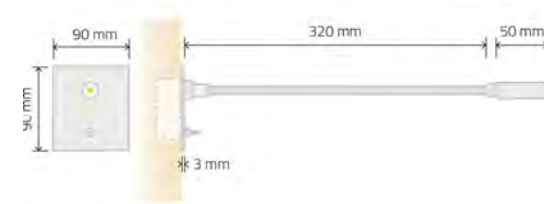

details

Finitions disponibles / Available finishes

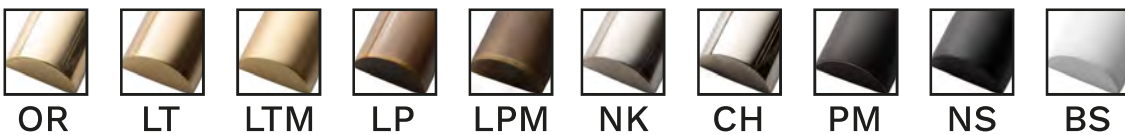

OR

LT

LTM

LP

LPM

NK

CH

PM

NS

BS

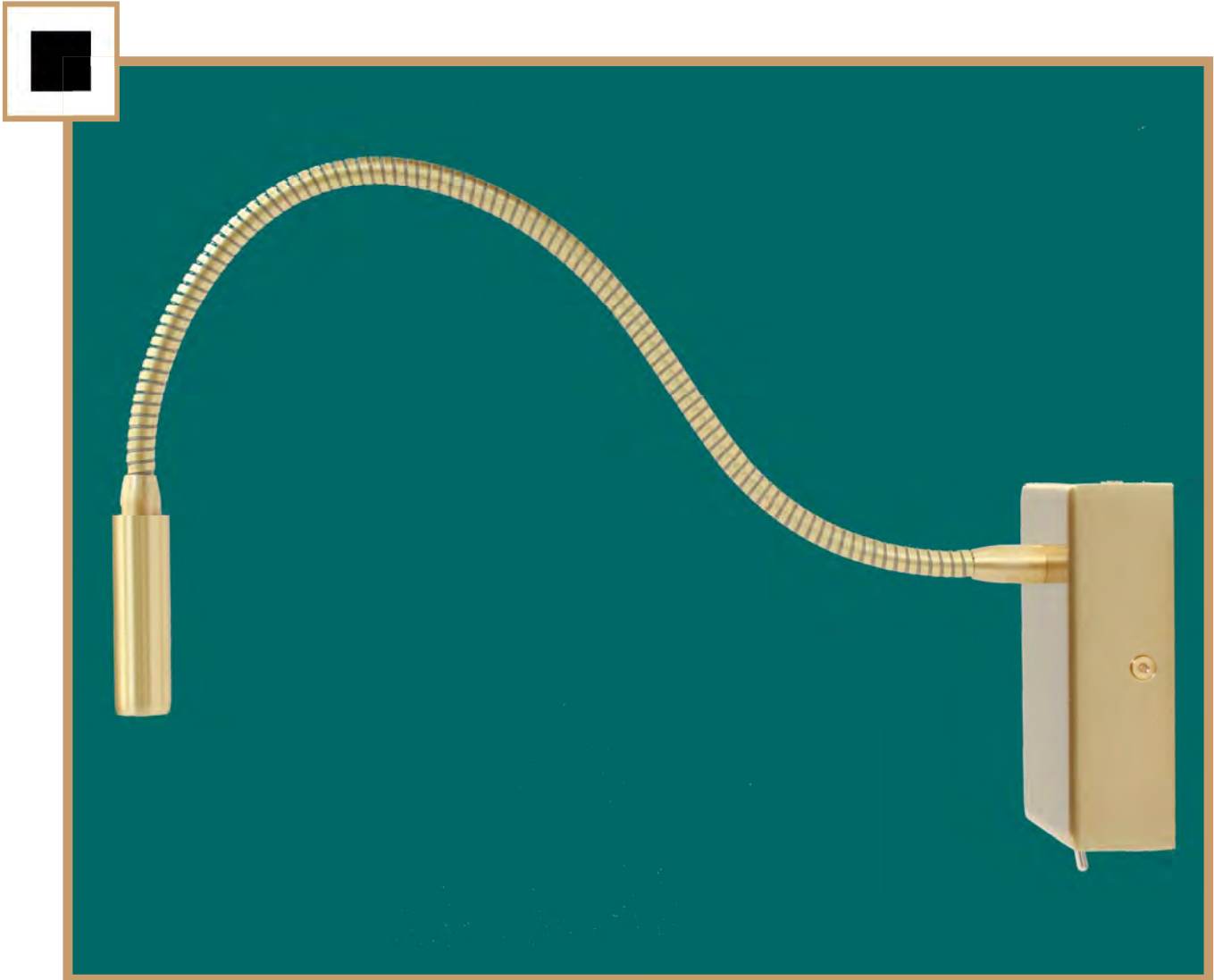

## Liseuse Reading lamp

### W47 30

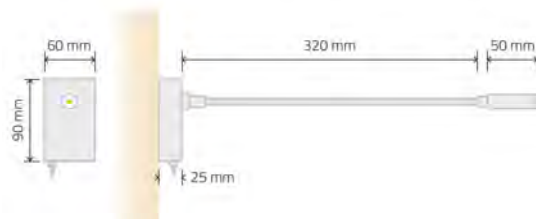

details

1W, 130 lumens, 2700K, CRI>90,  
Optique ajustable 8 à 60°

Finitions disponibles / Available finishes



OR



LT



LTM



LP



LPM



NK



CH



PM



NS



BS

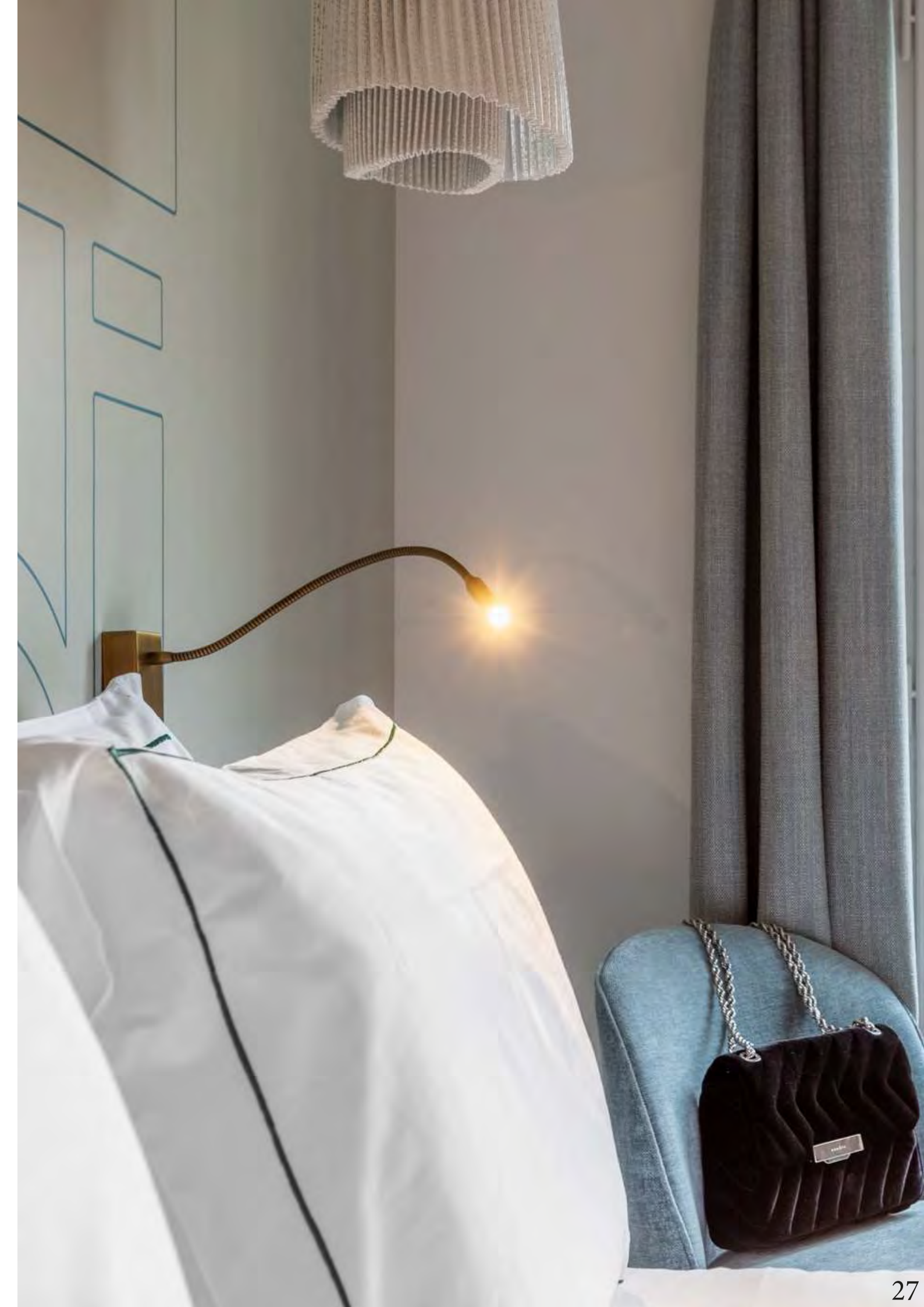









Liseuse  
Reading lamp

W47 35

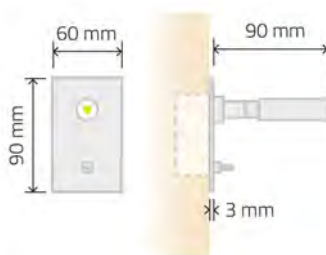

details

1W, 130 lumens, 2700K, CRI>90,  
Optique ajustable 8 à 60°

Finitions disponibles / Available finishes

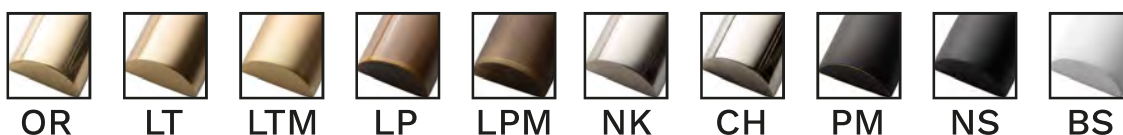

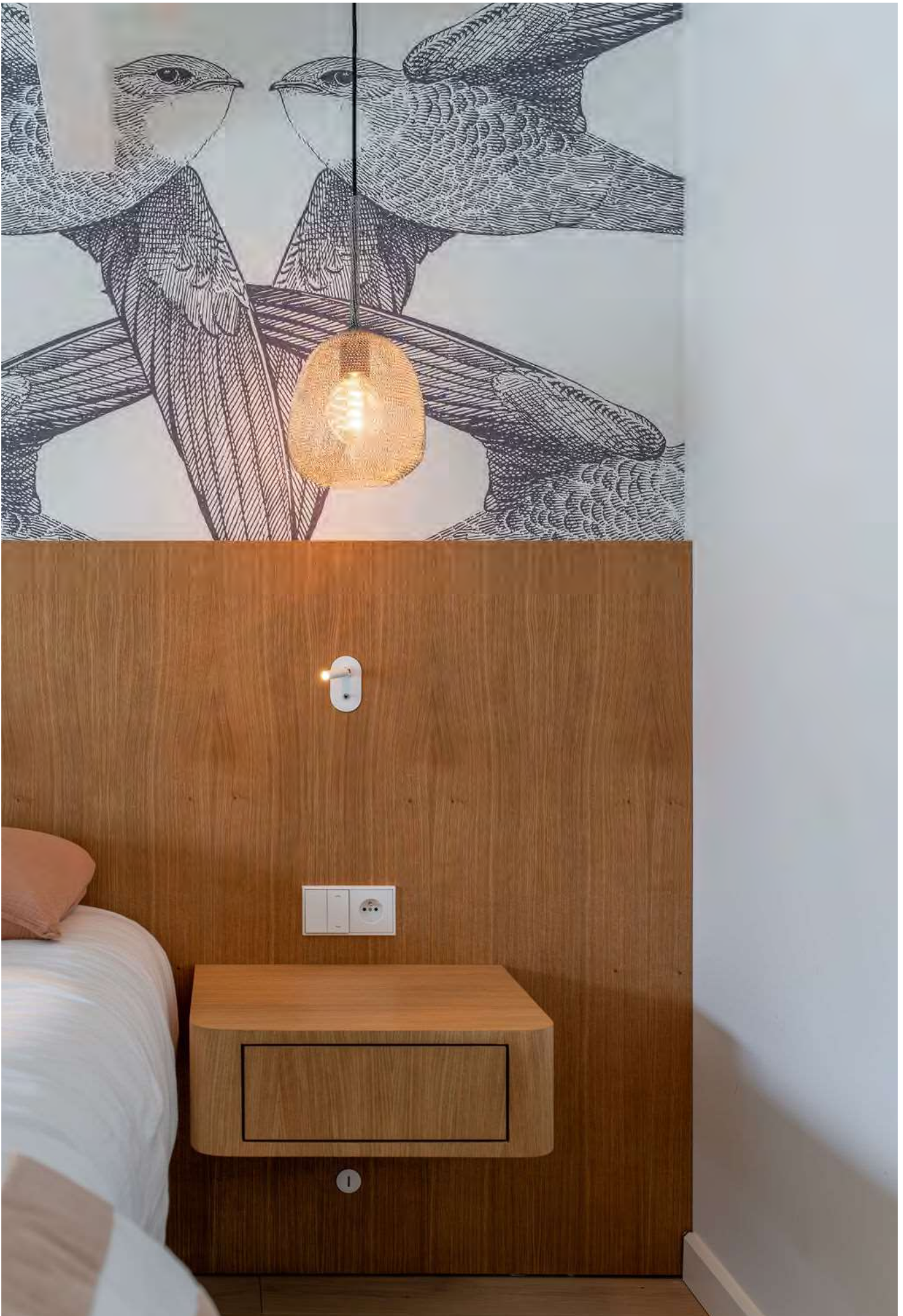



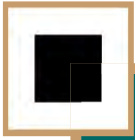

## Liseuse Reading lamp

### W47 37



details

1W, 130 lumens, 2700K, CRI>90,  
Optique ajustable 8 à 60°

Finitions disponibles / Available finishes

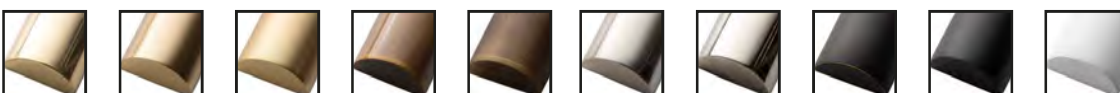

OR

LT

LTM

LP

LPM

NK

CH

PM

NS

BS







Liseuse  
Reading lamp

**W47 34**

1W, 130 lumens, 2700K, CRI>90,  
Optique ajustable 8 à 60°

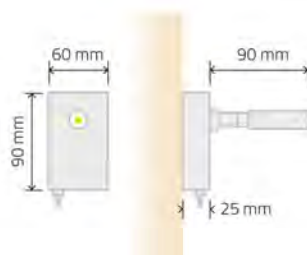

details

Finitions disponibles / Available finishes

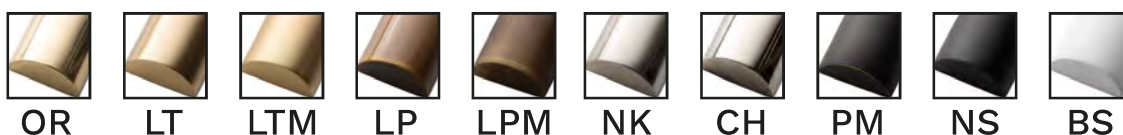



# COLLECTION ZOOM

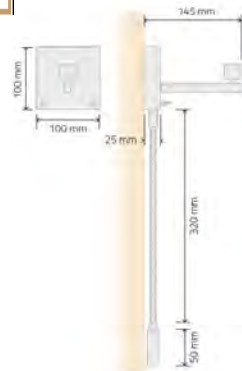
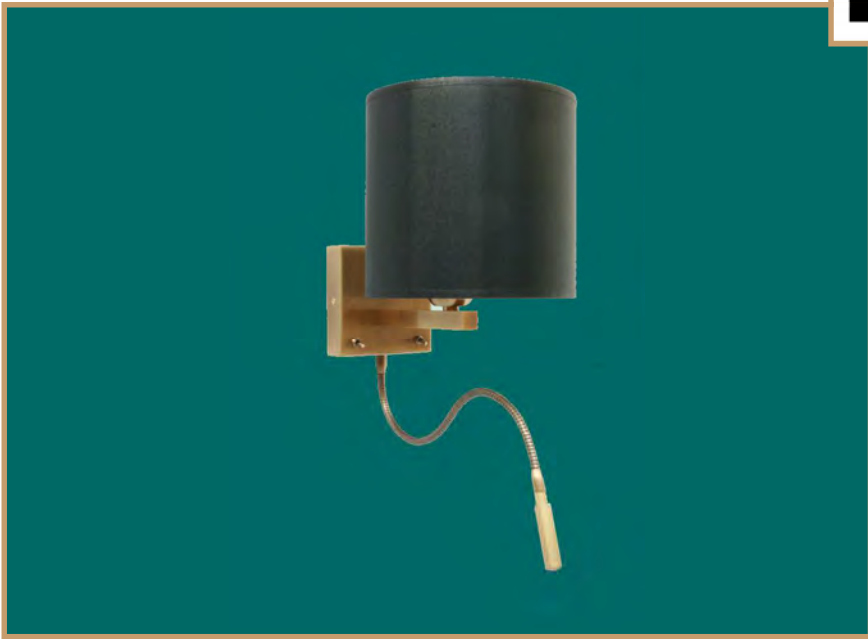

Liseuse  
Reading lamp

**W48 40**

1W + E27 , 130 lumens, 2700K,  
CRI>90, Optique ajustable 8 à 60°

Finitions disponibles / Available finishes

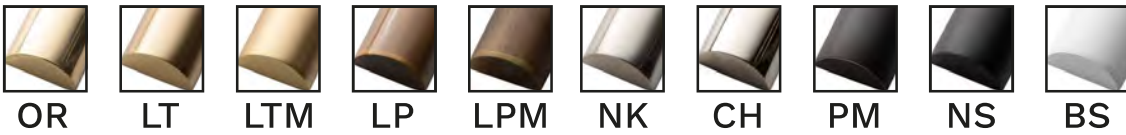

Produit livré sans  
abat-jout  
Product delivered  
without lampshade

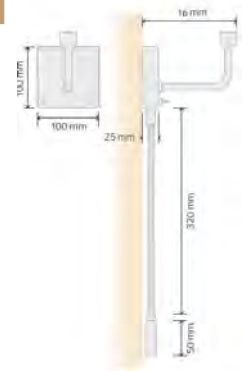
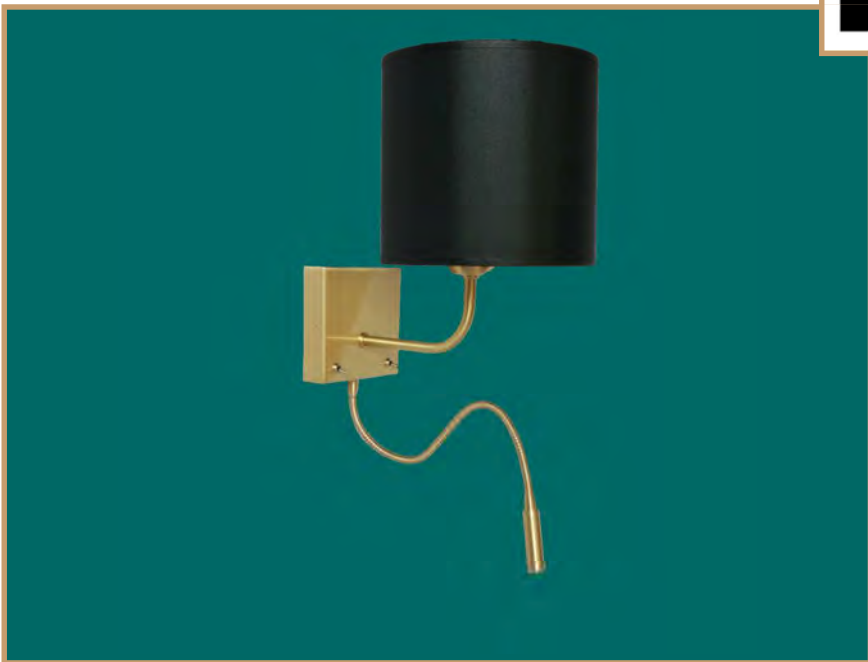

Liseuse  
Reading lamp

**W48 42**

1W + E27 , 130 lumens, 2700K,  
CRI>90, Optique ajustable 8 à 60°

Finitions disponibles / Available finishes

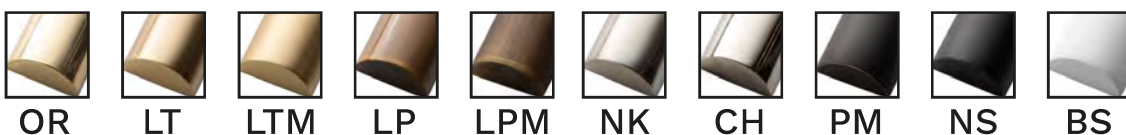

Produit livré sans  
abat-jout  
Product delivered  
without lampshade

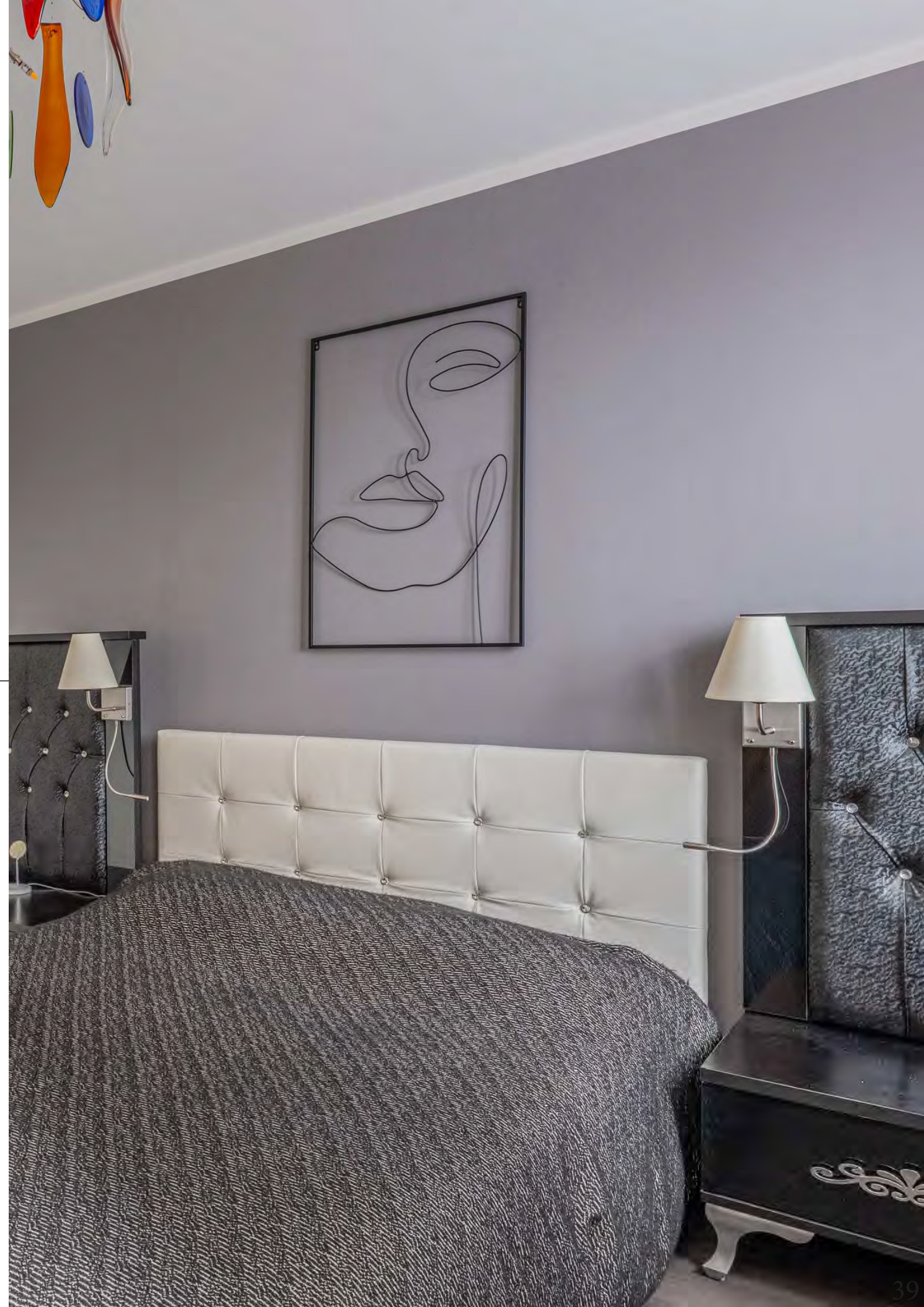





Liseuse  
Reading lamp

W48 43

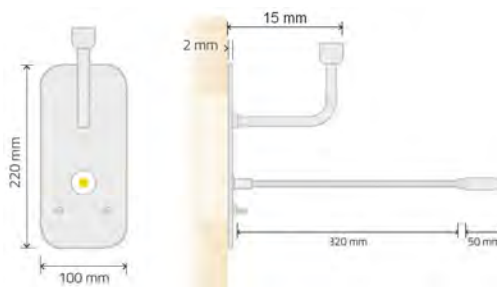

details

1W + E27, 130 lumens, 2700K, CRI>90,  
Optique ajustable 8 à 60°

Finitions disponibles / Available finishes

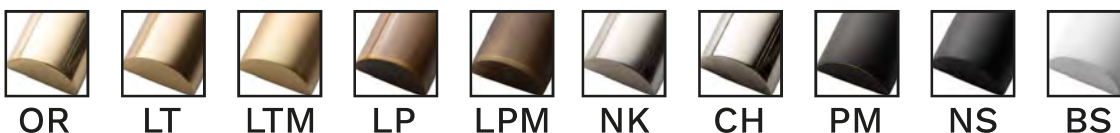

Produit livré sans  
abat-jout  
Product delivered  
without lampshade

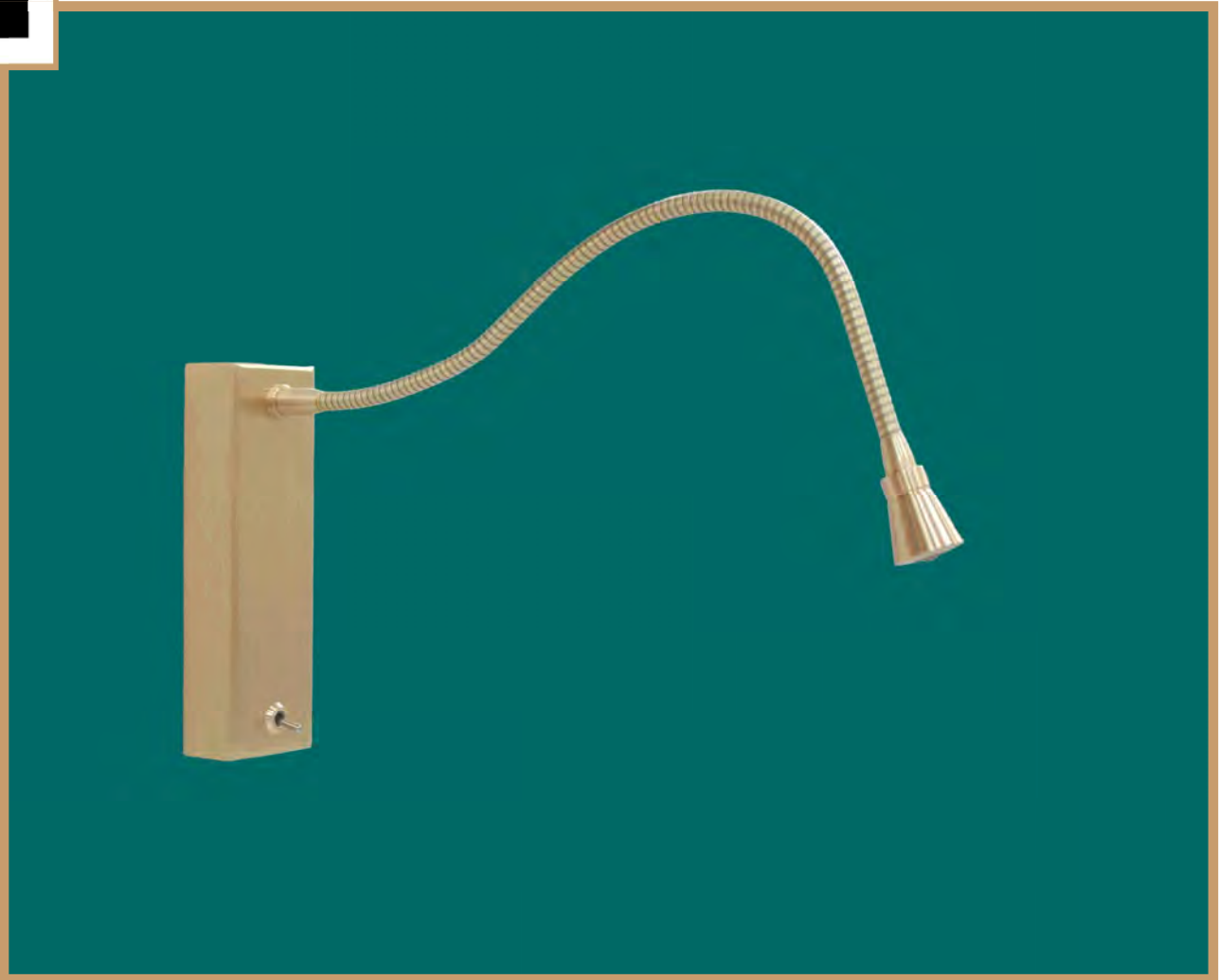
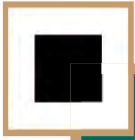

Liseuse  
Reading lamp

W44 30I

Nouveauté  
**MAISON & OBJET**  
NEW & NOW



details

1W, 130 lumens, 2700K, CRI>90

Finitions disponibles / Available finishes

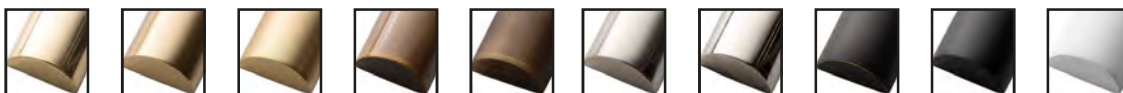

OR

LT

LTM

LP

LPM

NK

CH

PM

NS

BS



Liseuse  
Reading lamp

W44 31

Nouveauté  
**MAISON&OBJET**  
NEW & NOW



details

1W, 130 lumens, 2700K, CRI>90

Finitions disponibles / Available finishes

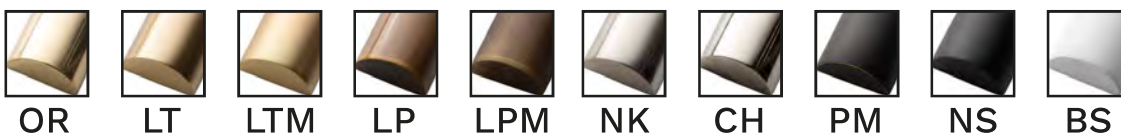



# COLLECTION PYXIS

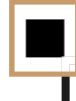

Liseuse  
Reading lamp

**W48 30**

1.5W, 190 lumens, 2700K,  
CRI>90, Optique 30°

Finitions disponibles / Available finishes

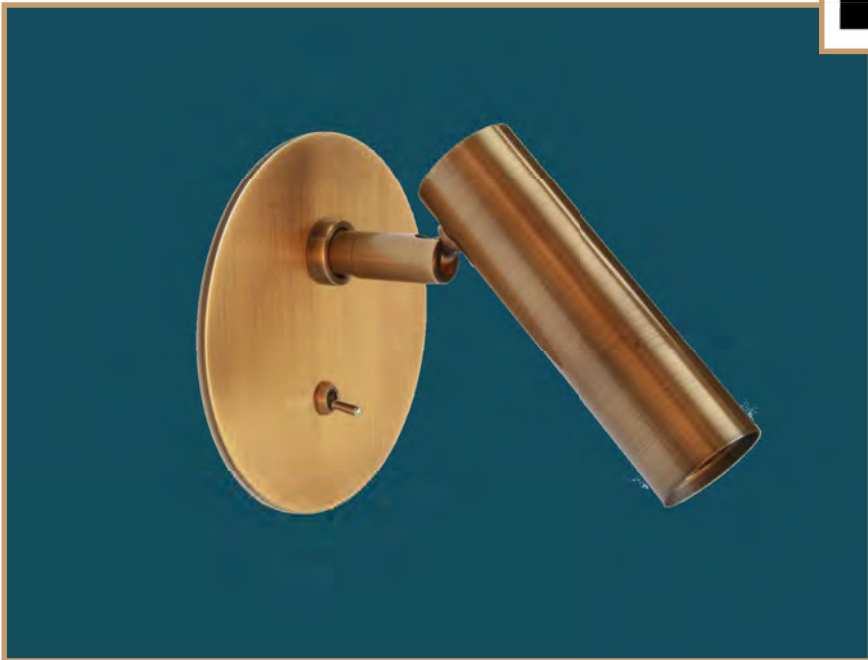
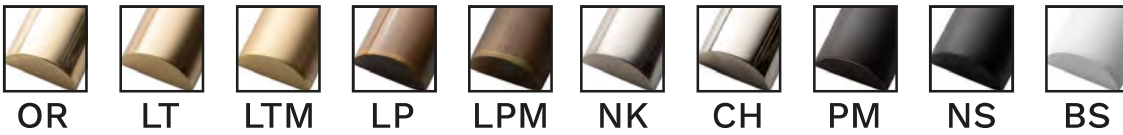

Liseuse  
Reading lamp

**W48 31**

1.5W, 190 lumens, 2700K,  
CRI>90, Optique 30°

Finitions disponibles / Available finishes

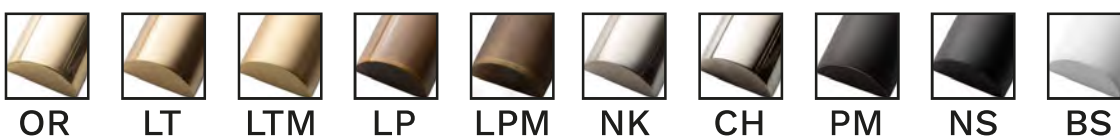

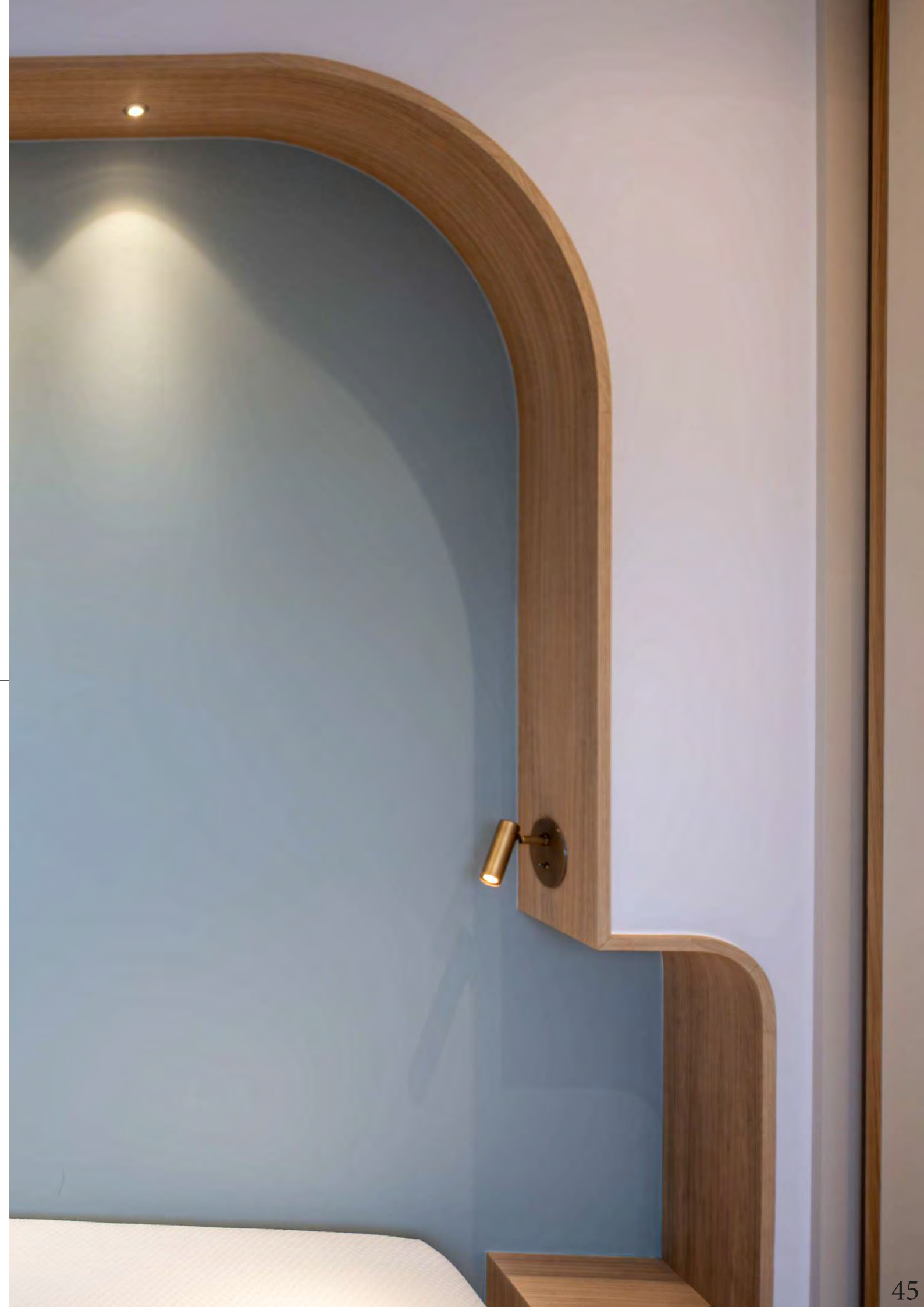





Liseuse  
Reading lamp

W48 21

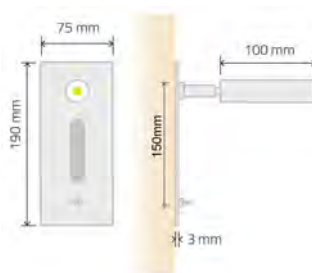

details

1.5W, 190 lumens, 2700K, CRI>90, Optique 30°

Finitions disponibles / Available finishes

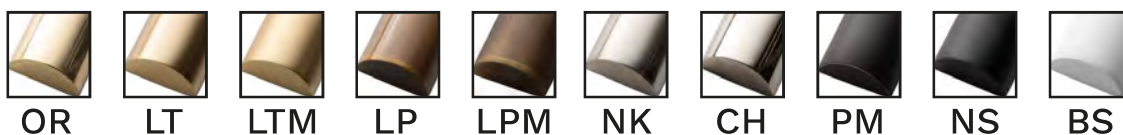



Liseuse  
Reading lamp

W48 20

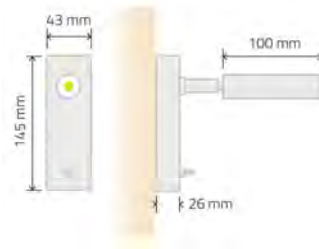

details

1.5W, 190 lumens, 2700K, CRI>90, Optique 30°

Finitions disponibles / Available finishes

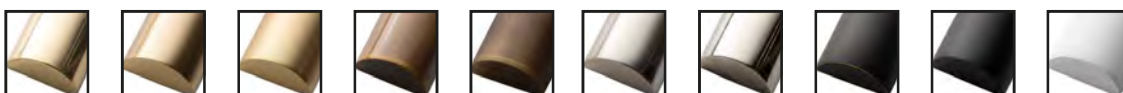

OR

LT

LTM

LP

LPM

NK

CH

PM

NS

BS





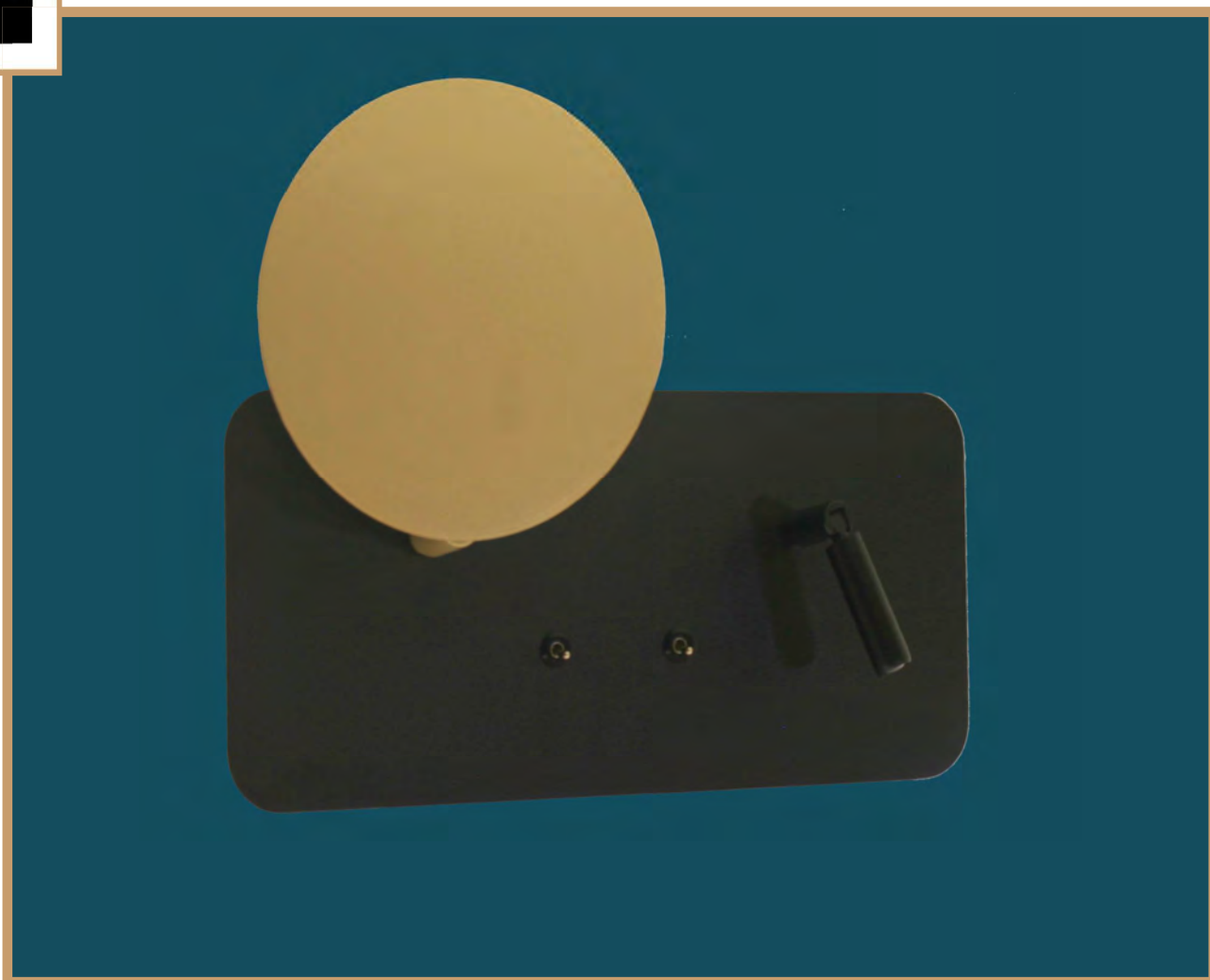

Liseuse  
Reading lamp

W41 30

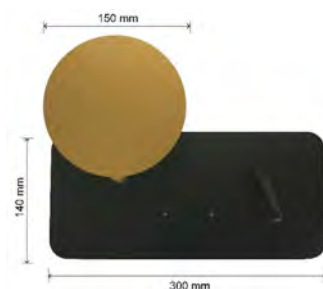

details

1W+G9, 130 lumens, 2700K, CRI>90, Optique 30°

Finitions disponibles / Available finishes



NS



BS



ELT

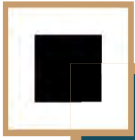

Liseuse  
Reading lamp

W41 40

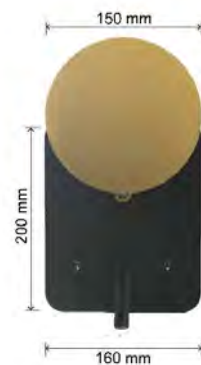

details

1W+G9, 130 lumens, 2700K, CRI>90, Optique 30°

Finitions disponibles / Available finishes



NS



BS



ELT









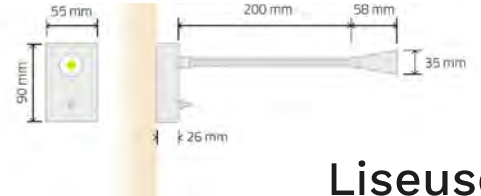
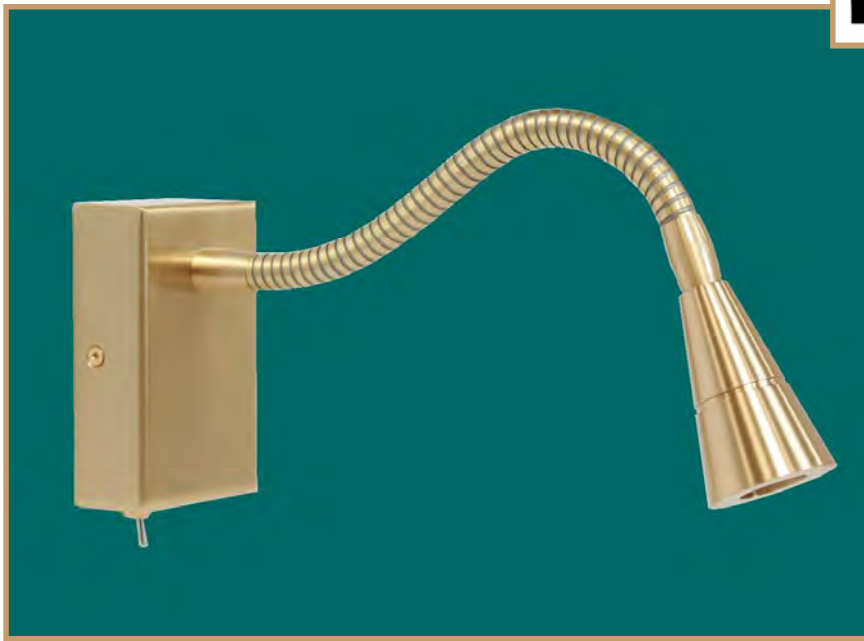

Liseuse  
Reading lamp

**W46 20**

1.5W, 190 lumens, 2700K,  
CRI>90, Optique 30°

Finitions disponibles / Available finishes



OR

LT

LTM

LP

LPM

NK

CH

PM

NS

BS

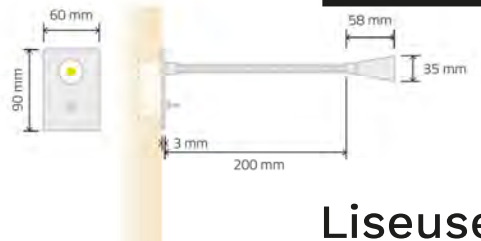

Liseuse  
Reading lamp

**W46 21**

1.5W, 190 lumens, 2700K,  
CRI>90, Optique 30°

Finitions disponibles / Available finishes



OR

LT

LTM

LP

LPM

NK

CH

PM

NS

BS



# COLLECTION I LIGHT

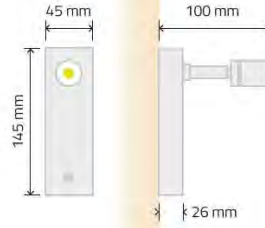

Liseuse  
Reading lamp

**W44 20**

1.5W, 190 lumens, 2700K,  
CRI>90, Optique 30°

Finitions disponibles / Available finishes

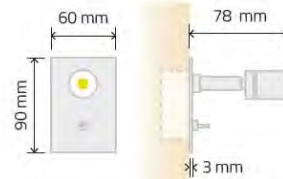
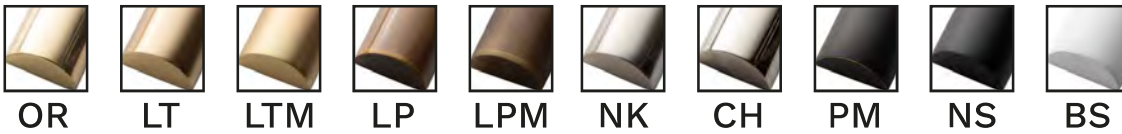

Liseuse  
Reading lamp

**W44 21**

1.5W, 190 lumens, 2700K,  
CRI>90, Optique 30°

Finitions disponibles / Available finishes

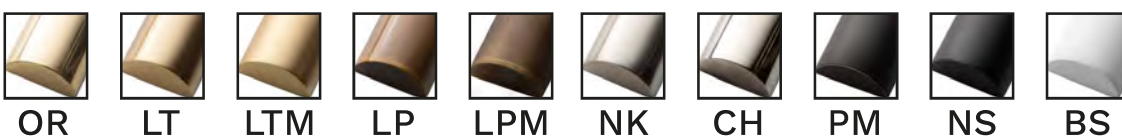







Liseuse  
Reading lamp

W45 30

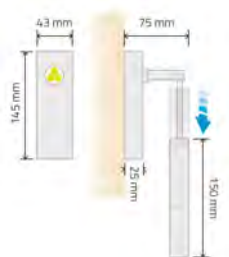

details

3W, 360 lumens, 2700K, CRI>90, Optique 30°

Finitions disponibles / Available finishes

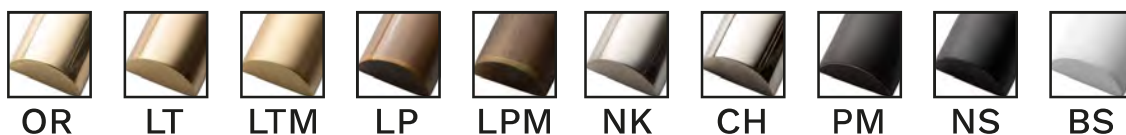

OR

LT

LTM

LP

LPM

NK

CH

PM

NS

BS



# COLLECTION POWER

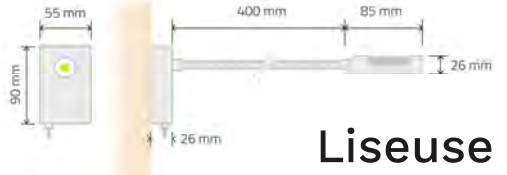

Liseuse  
Reading lamp

**W45 10**

1.5W, 190 lumens, 2700K,  
CRI>90, Optique 30°

Finitions disponibles / Available finishes

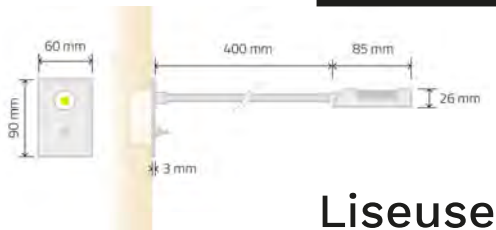
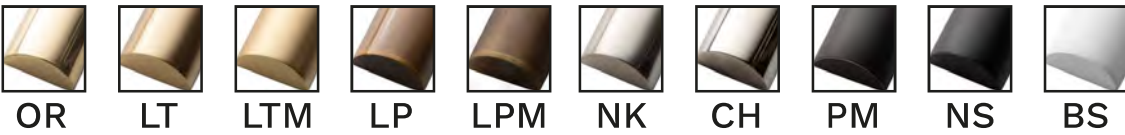

Liseuse  
Reading lamp

**W45 11**

1.5W, 190 lumens, 2700K,  
CRI>90, Optique 30°

Finitions disponibles / Available finishes

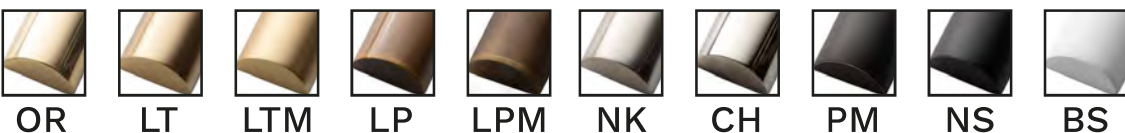





VIS DE B



Spot Projecteur  
Spotlight

**W45 20**

3W, 360 lumens, 2700K,  
CRI>90, Optique 25°

Finitions disponibles / Available finishes



OR

LT

LTM

LP

LPM

NK

CH

PM

NS

BS

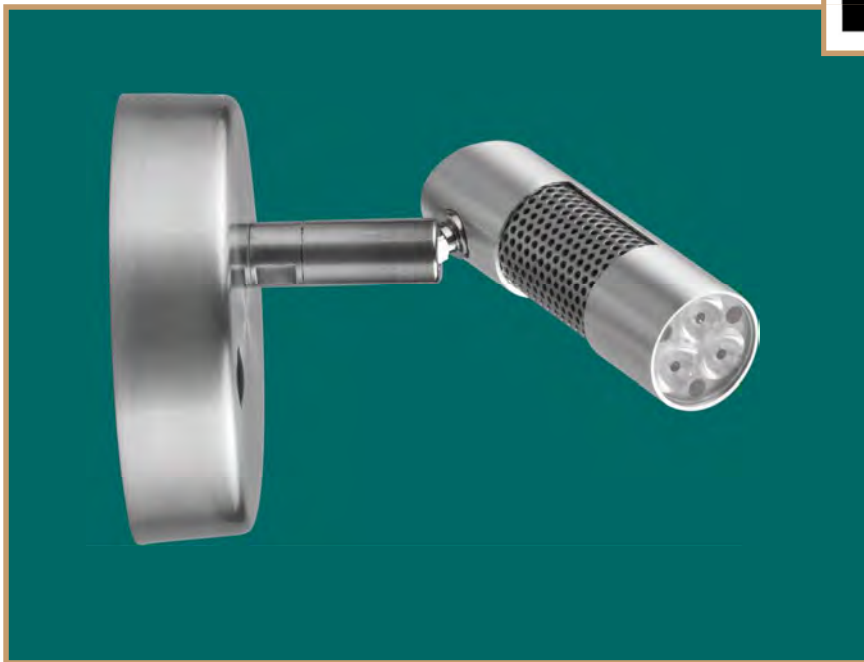

Spot Projecteur  
Spotlight

**W45 21**

3W, 360 lumens, 2700K,  
CRI>90, Optique 25°

Finitions disponibles / Available finishes



OR

LT

LTM

LP

LPM

NK

CH

PM

NS

BS



## Spot Projecteur Spotlight

### W47 20



details

7W, 820 lumens, 2700K, CRI>90, Optique 50°

Finitions disponibles / Available finishes



OR



LT



LTM



LP



LPM



NK



CH



PM



NS



BS





# COLLECTION BABY I LIGHT

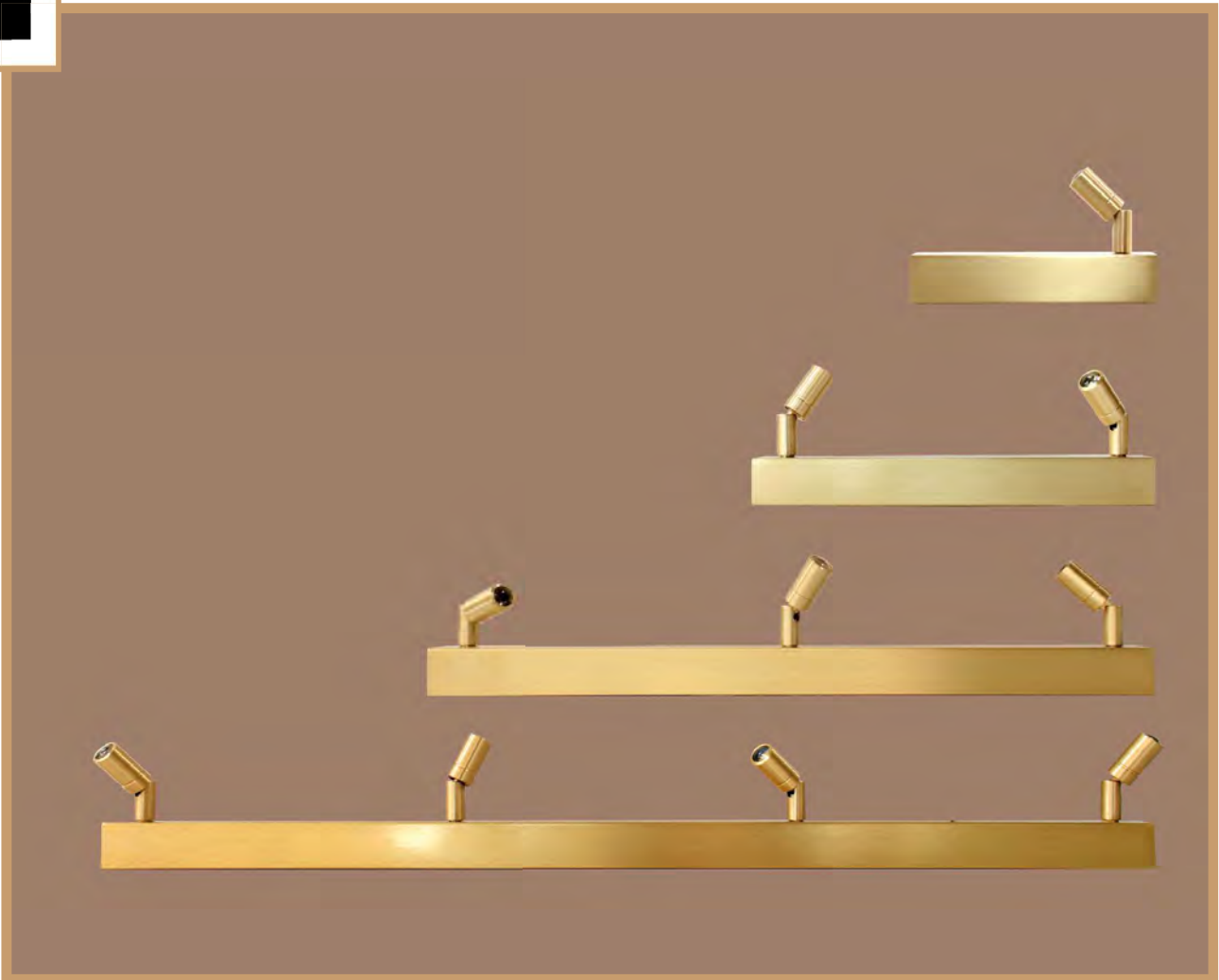

Spot Projecteur  
Spotlight

W44 40

Reglette LED 1 à 4 sources  
Spotlight with 1 to 4 sources

Nouveauté  
**MAISON&OBJET**  
NEW&NOW



details

Finitions disponibles / Available finishes



OR



LT



LTM



LP



LPM



NK



CH



PM



NS



BS

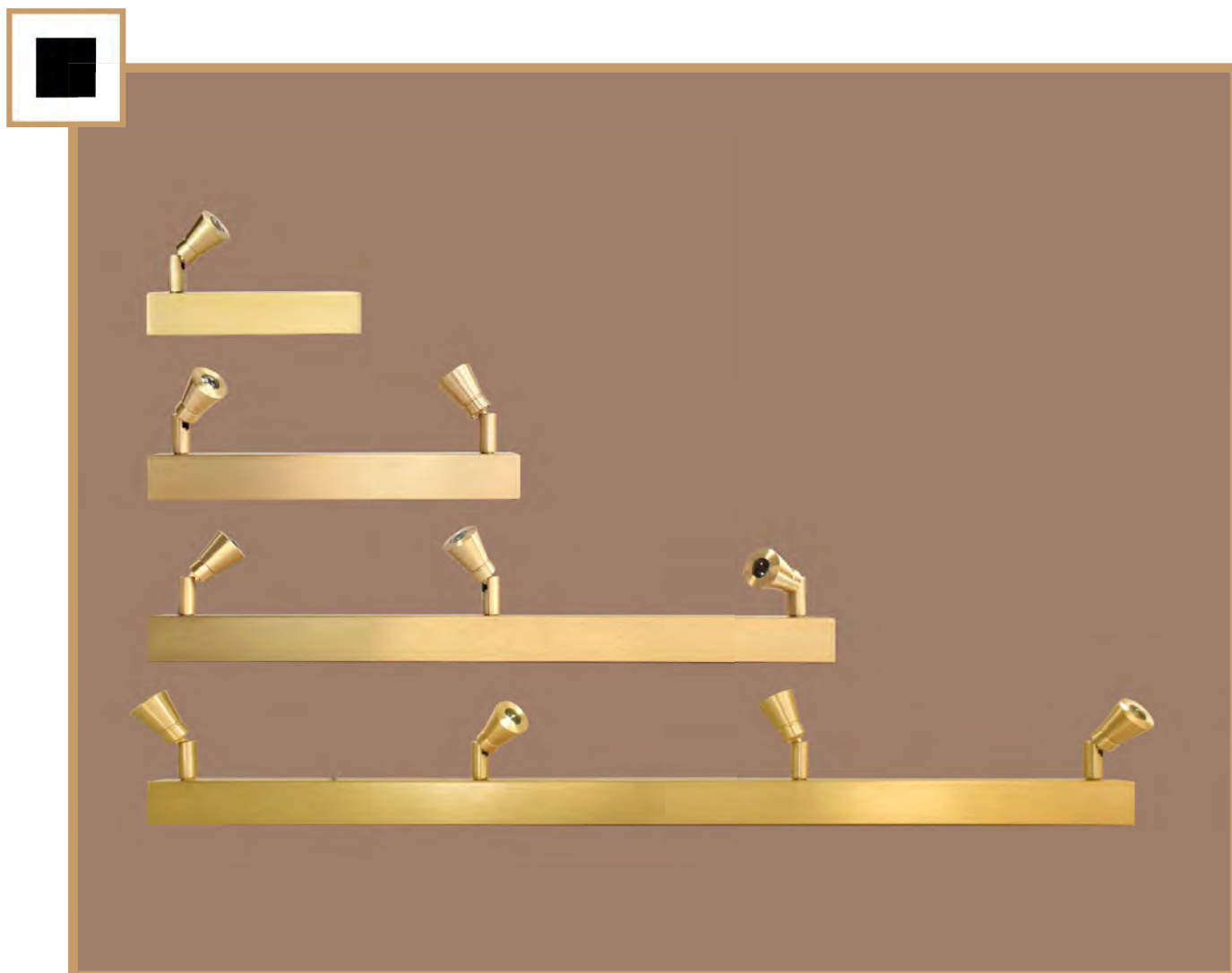

Spot Projecteur  
Spotlight

W44 30

Reglette 1 à 4 sources  
Spotlight with 1 to 4 sources

Nouveauté  
**MAISON&OBJET**  
NEW&NOW



details

Finitions disponibles / Available finishes

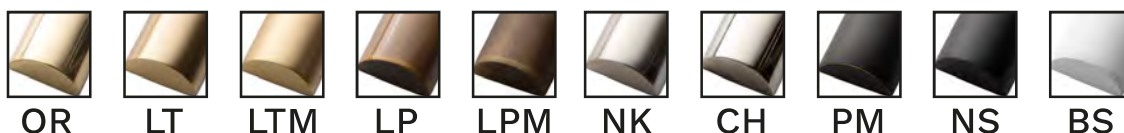

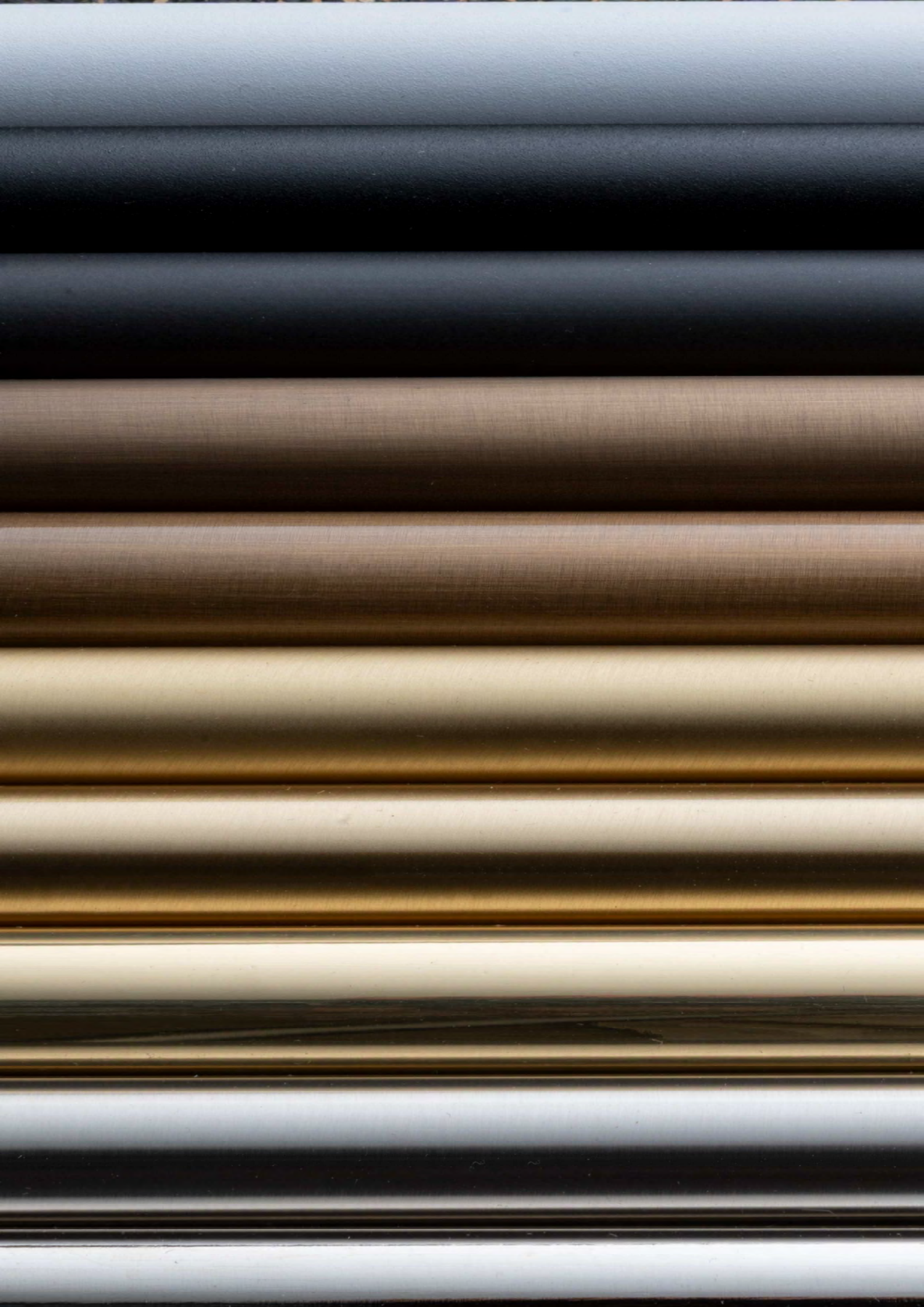



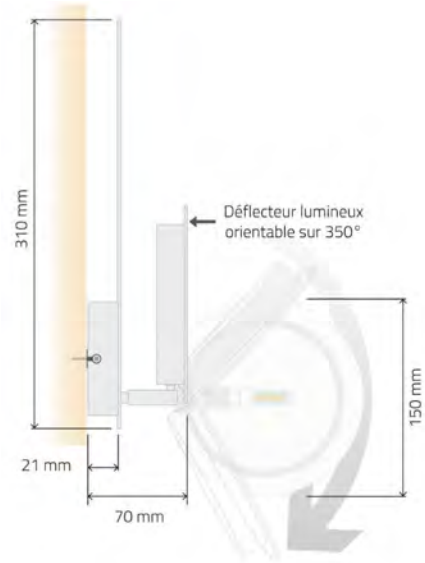
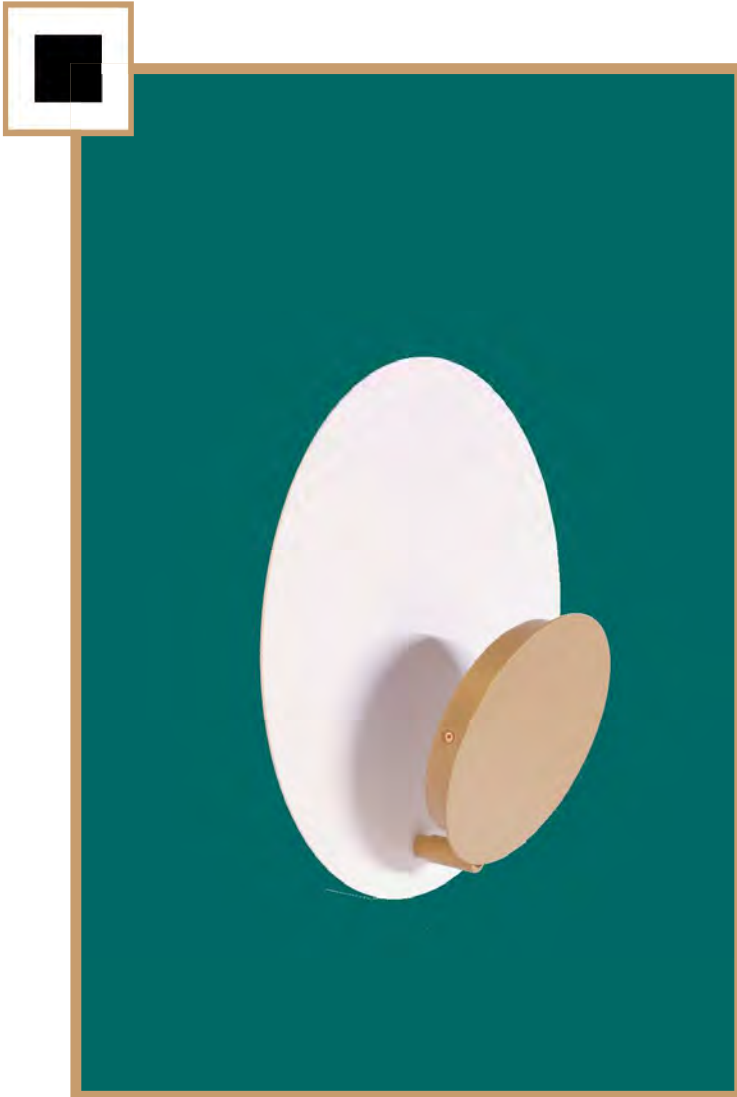

Applique Murale  
Wall lamp

W41 10

Ampoule G9, Disque orientable  
G9 bulb, adjustable disc



details

Finitions disponibles / Available finishes



NS



BS



ELT





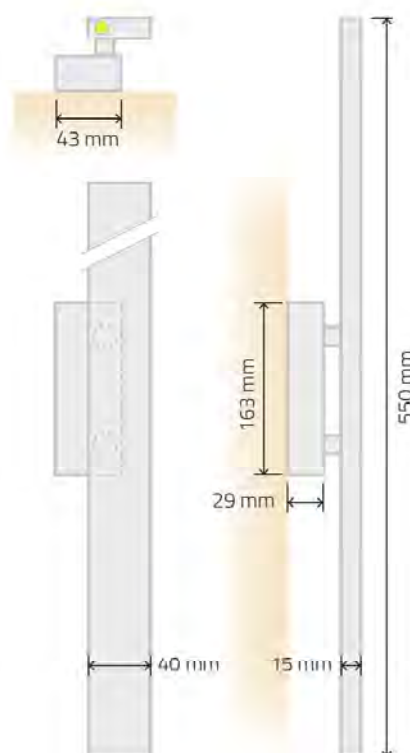

## Applique Murale Wall lamp

### W47 11

22W, 2240 lumens



details

Finitions disponibles / Available finishes



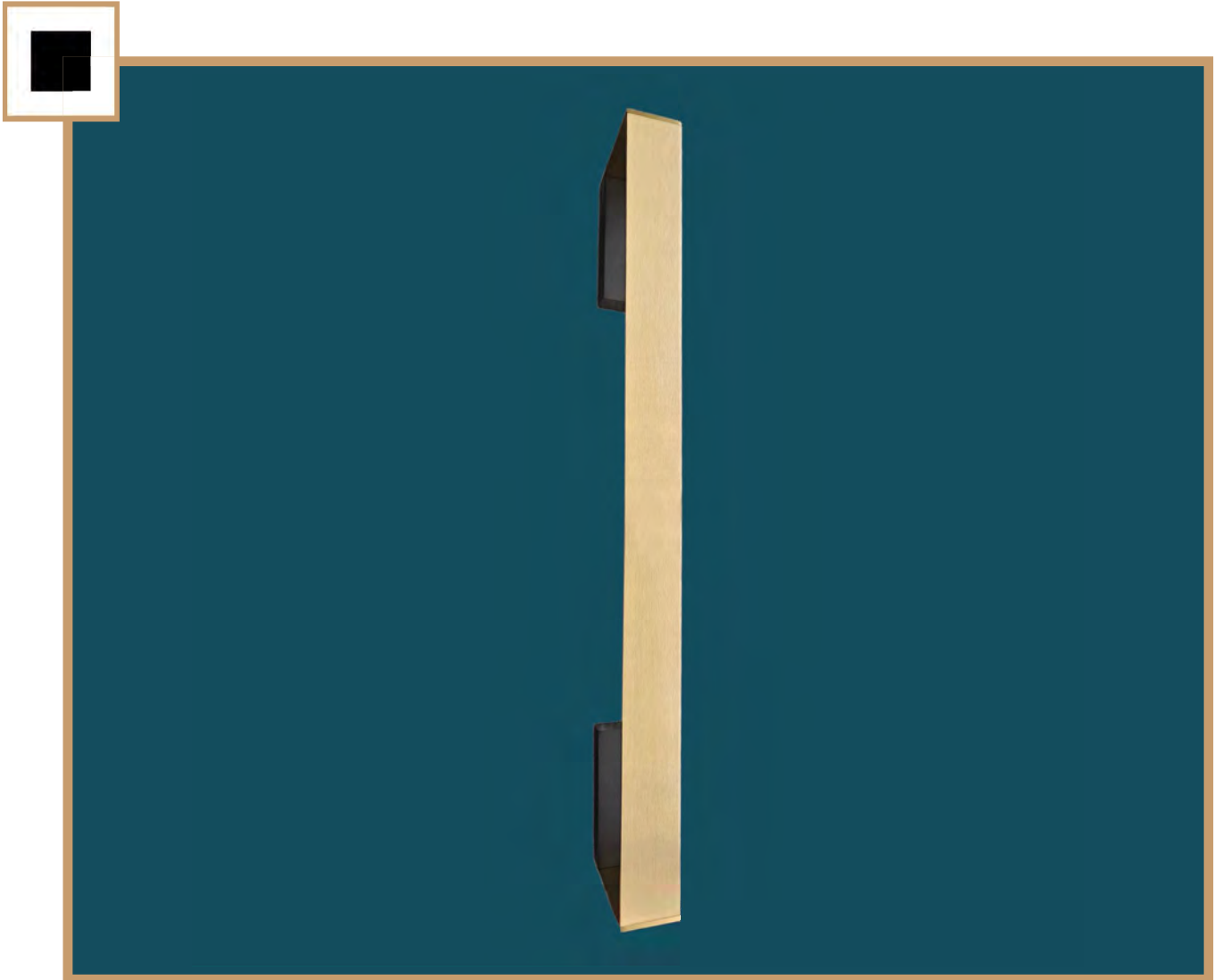

Applique Murale  
Wall lamp

L45 40

---

Disponible en 20, 40, 60 et 80cm  
Available in 20, 40, 60 and 80 cm

---

Finitions disponibles / Available finishes

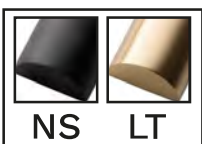

Nouveauté  
**MAISON&OBJET**  
NEW & NOW



details

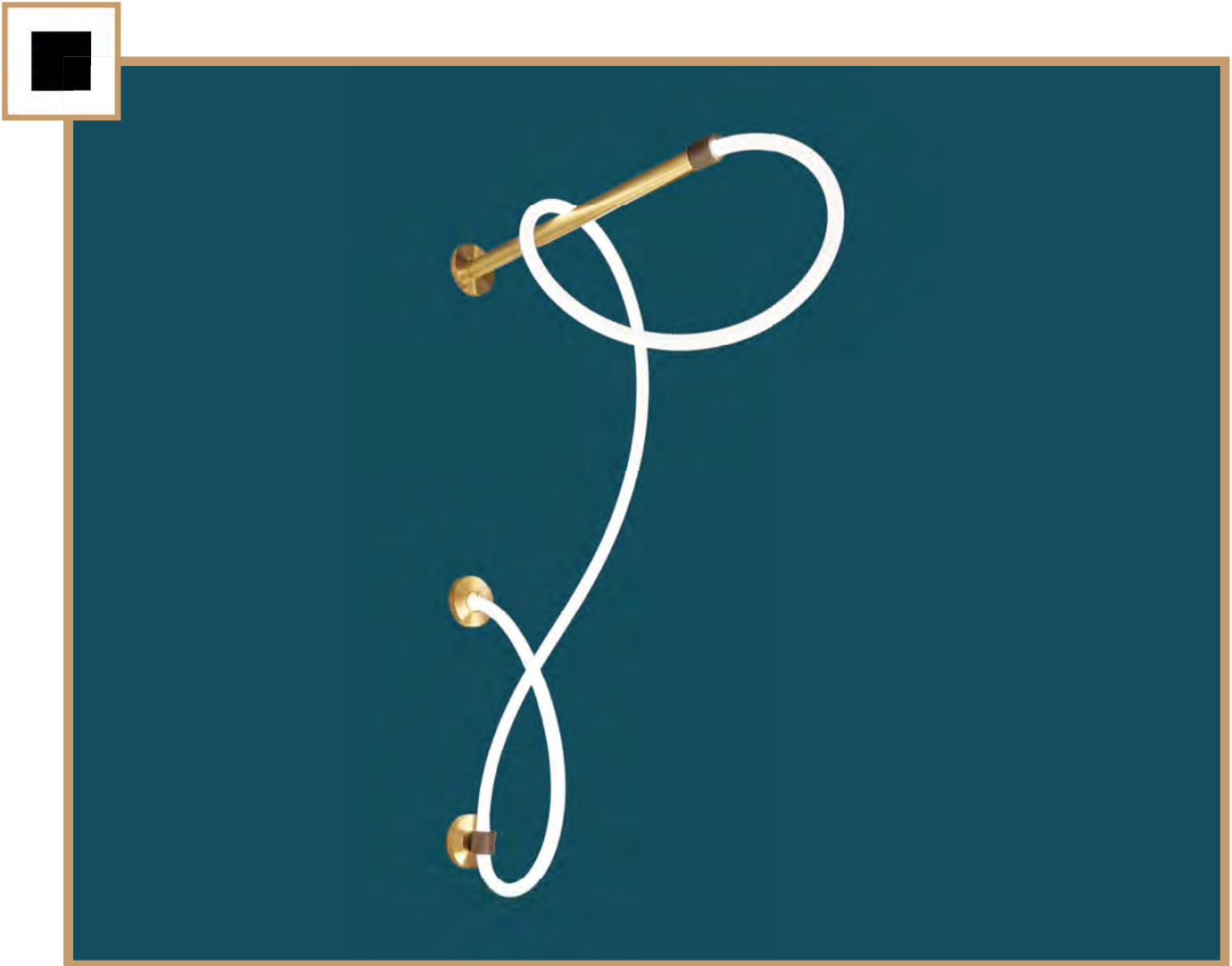

Applique Murale  
Wall lamp

145 40

Modulable  
Modular

Nouveauté  
**MAISON & OBJET**  
NEW & NOW



details

Finitions disponibles / Available finishes

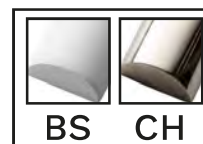
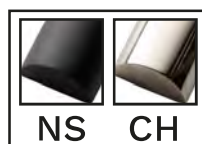
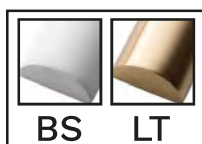
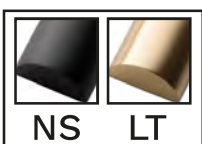





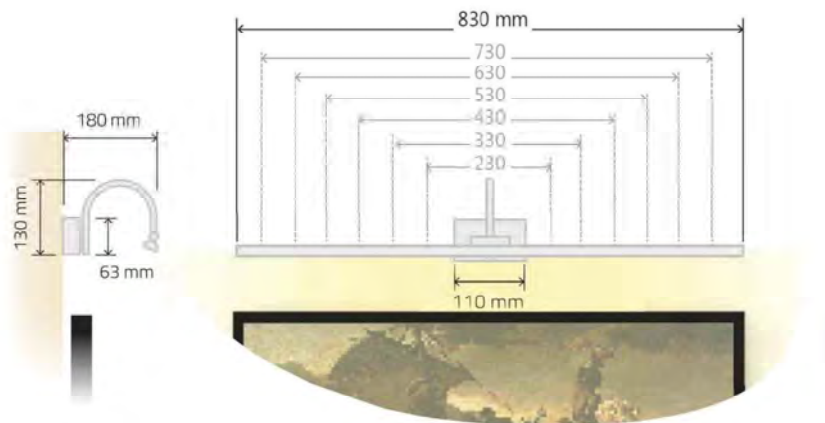
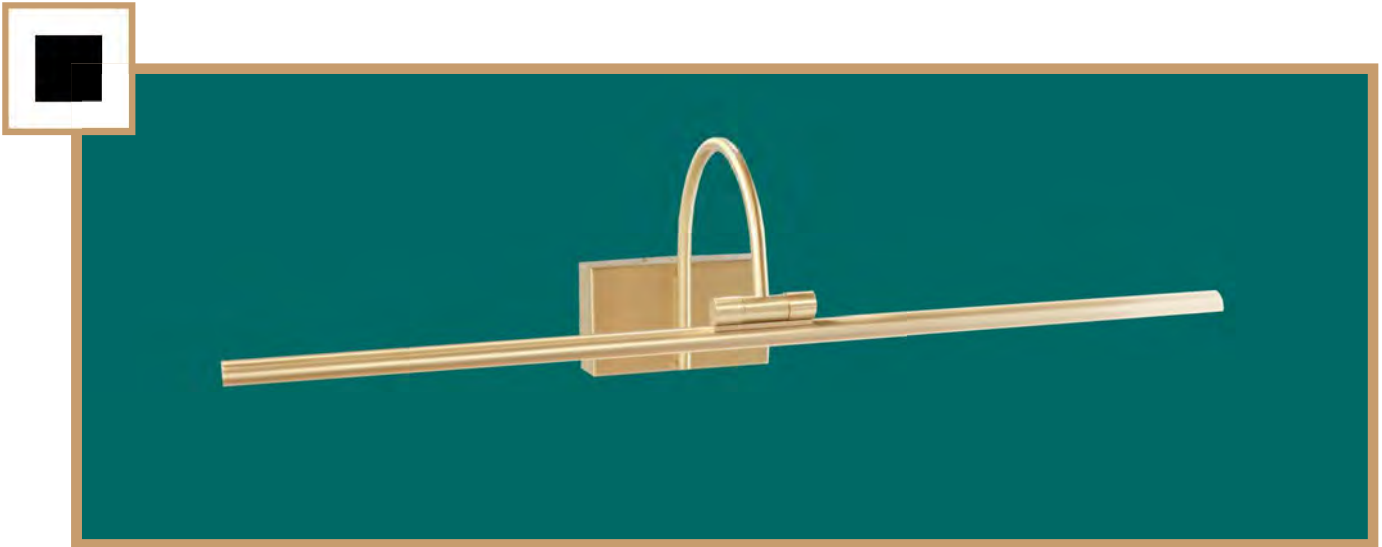

## Applique Tableaux Wall Picture Lamp

### W42 01

Disponible en 23, 33, 43, 53, 63, 73 et 83cm  
Available in 23, 33, 43, 53, 63, 73 and 83cm



details

Finitions disponibles / Available finishes

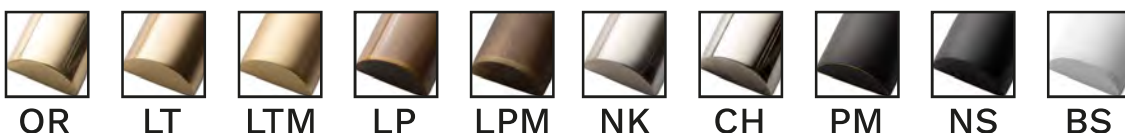

OR

LT

LTM

LP

LPM

NK

CH

PM

NS

BS





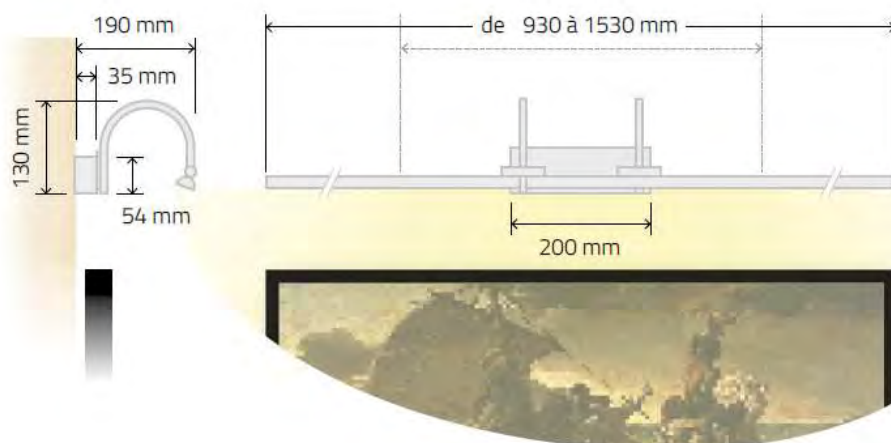

## Applique Tableaux Wall Picture Lamp

### W42 01 15

Disponible en 93, 103, 113, 123, 133, 143 et 153cm  
Available in 93, 103, 113, 123, 133, 143 and 153cm



details

Finitions disponibles / Available finishes

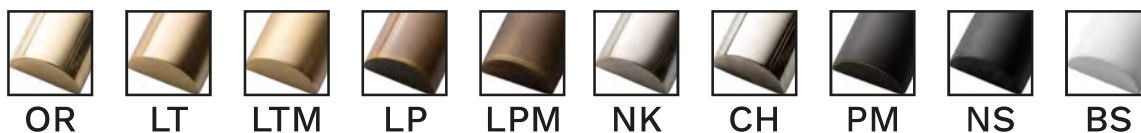

OR

LT

LTM

LP

LPM

NK

CH

PM

NS

BS

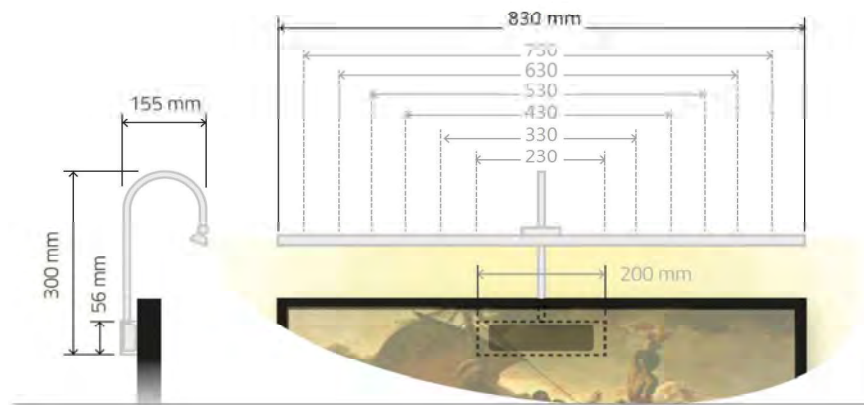

## Applique Tableaux Wall Picture Lamp

### W42 02

Disponible en 23, 33, 43, 53, 63, 73 et 83cm  
Available in 23, 33, 43, 53, 63, 73 and 83cm



details

Finitions disponibles / Available finishes

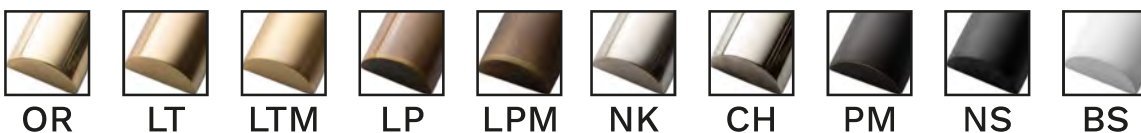





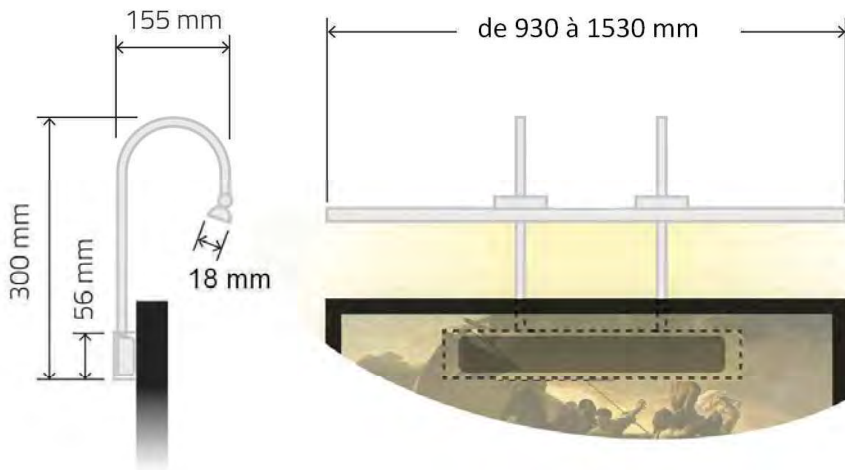
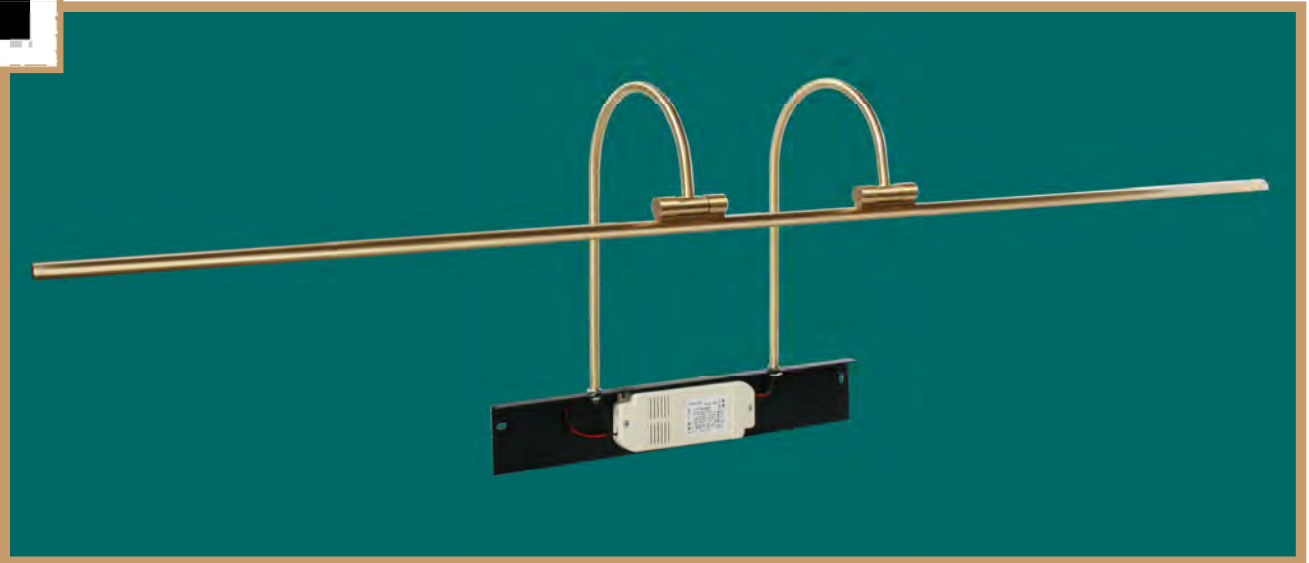
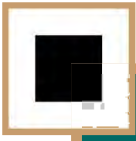

## Applique Tableaux Wall Picture Lamp

### W42 02 15

Disponible en 93, 103, 113, 123, 133, 143 et 153cm  
Available in 93, 103, 113, 123, 133, 143 and 153cm



details

Finitions disponibles / Available finishes

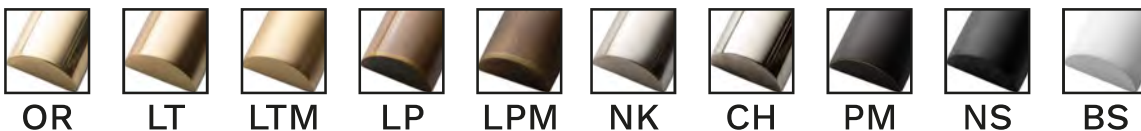

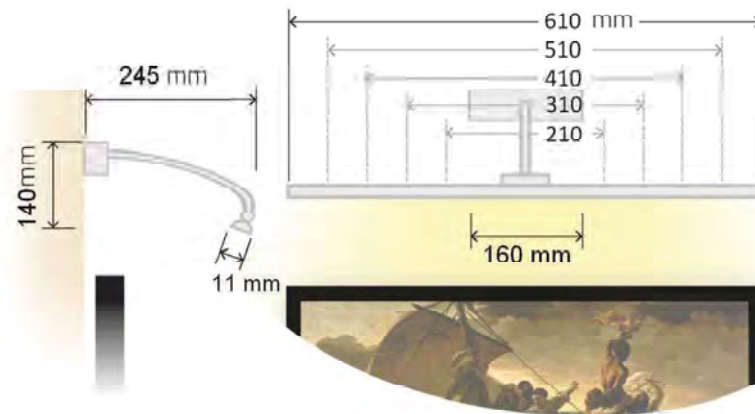
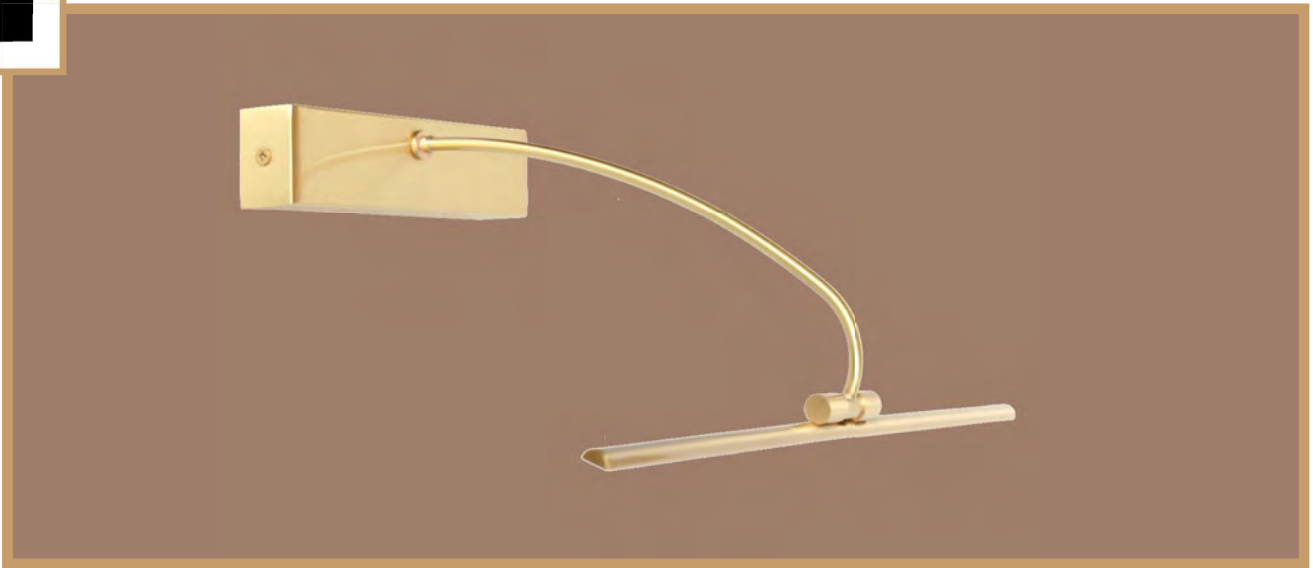

## Applique Tableaux Wall Picture Lamp

### W40 01

Disponible en 21, 31, 41, 51 et 61cm  
Available in 21, 31, 41, 51 et 61cm



details

Finitions disponibles / Available finishes



OR



LT



LTM



LP



LPM



NK



CH



PM



NS



BS





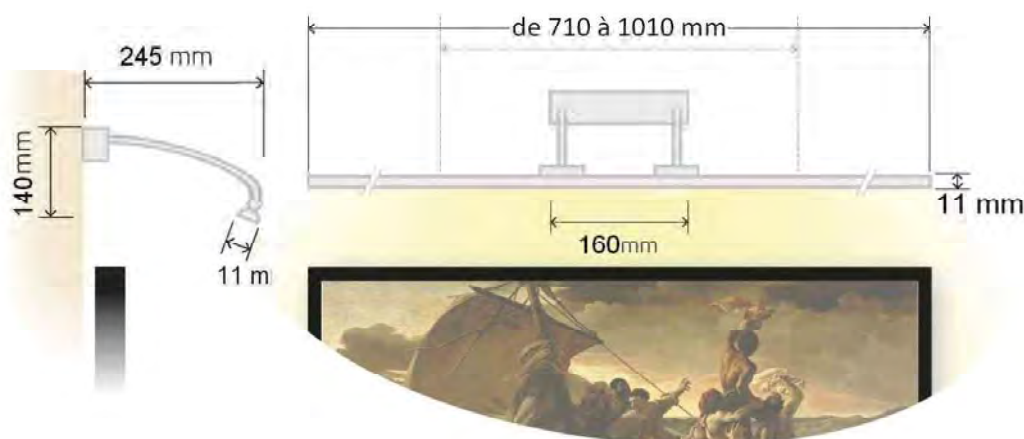
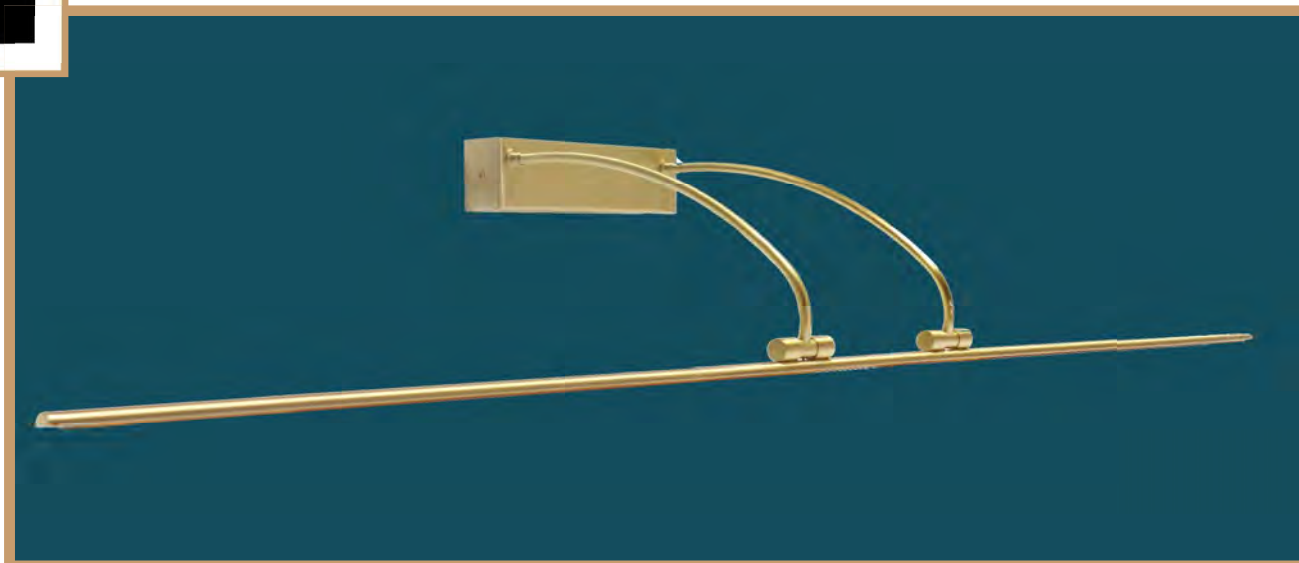

## Applique Tableaux Wall Picture Lamp

### W40 01 10

Disponible en 71, 81, 91 et 101cm  
Available in 71, 81, 91 and 101cm



details

Finitions disponibles / Available finishes

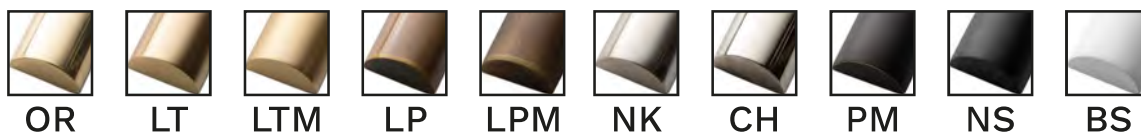

OR

LT

LTM

LP

LPM

NK

CH

PM

NS

BS

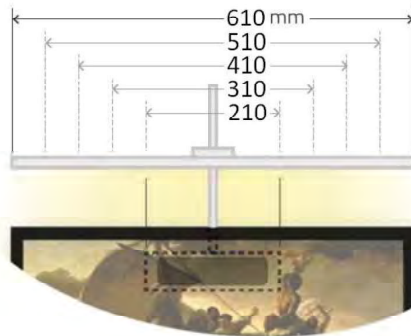
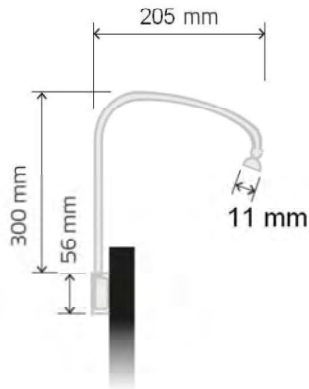

## Applique Tableaux Wall picture Lamp

### W40 02

Disponible en 21, 31, 41, 51 et 61cm  
Available in 21, 31, 41, 51 et 61cm



details

Finitions disponibles / Available finishes

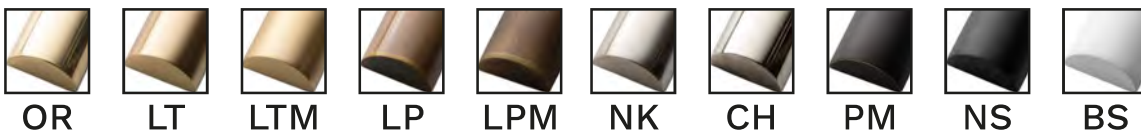





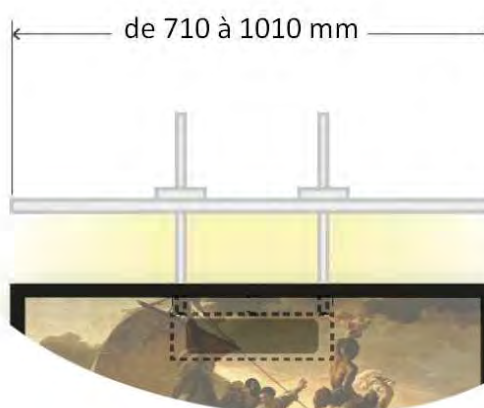
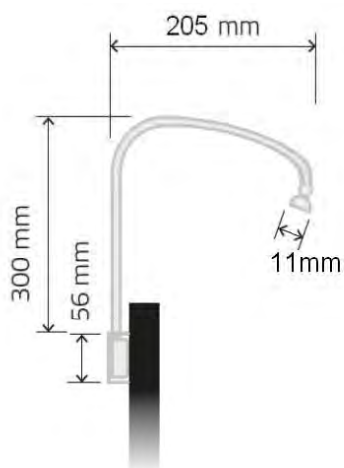

## Applique Tableaux Wall Picture Lamp

### W40 02 10

Disponible en 71, 81, 91 et 101cm  
Available in 71, 81, 91 and 101cm



details

Finitions disponibles / Available finishes

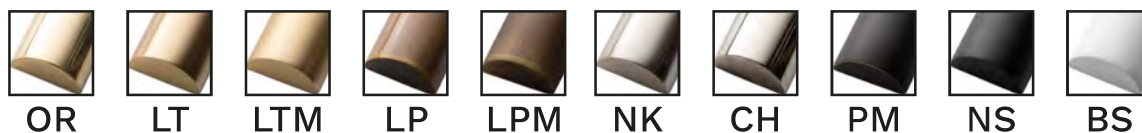

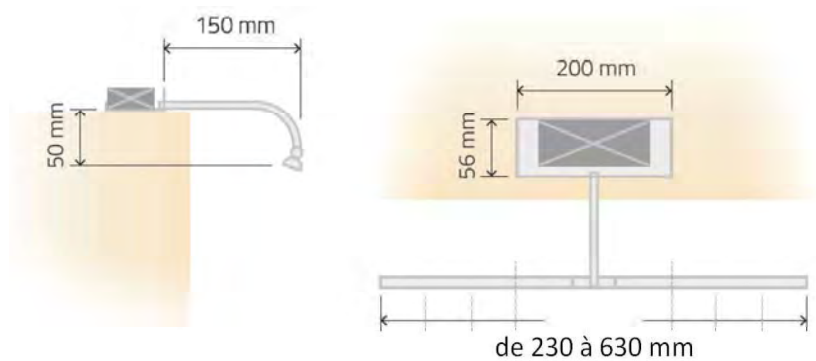
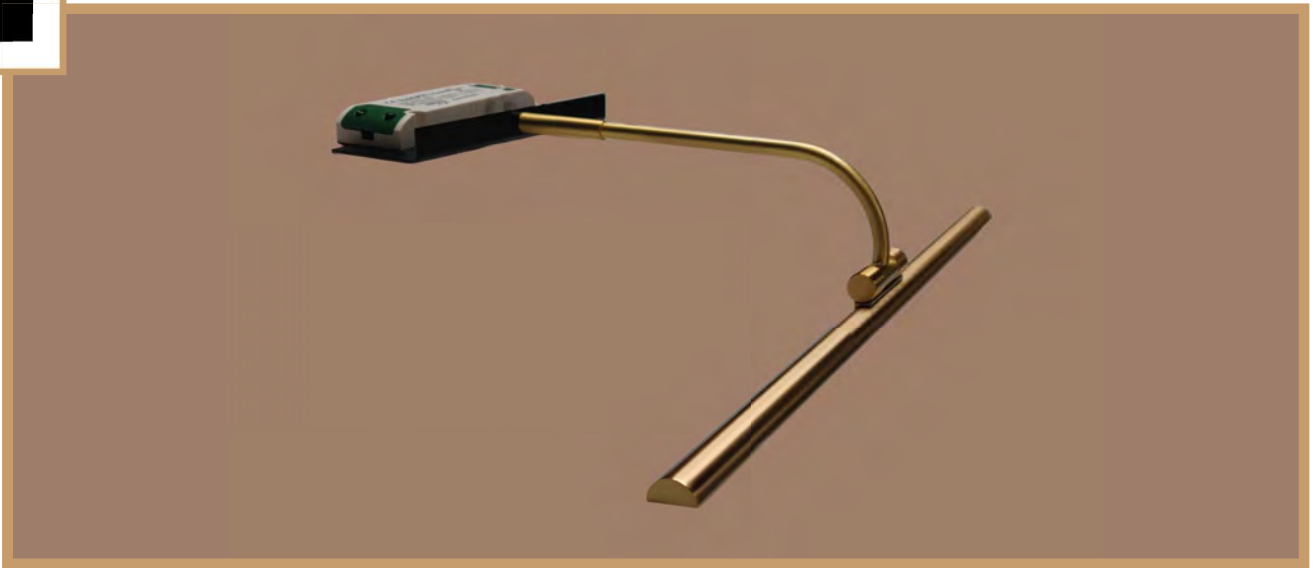

## Applique Tableaux bibliotheque Wall Picture Lamp for library

### W42 03

Disponible en 23, 33, 43, 53 et 63cm  
Available in 23, 33, 43, 53 et 63cm



details

Finitions disponibles / Available finishes

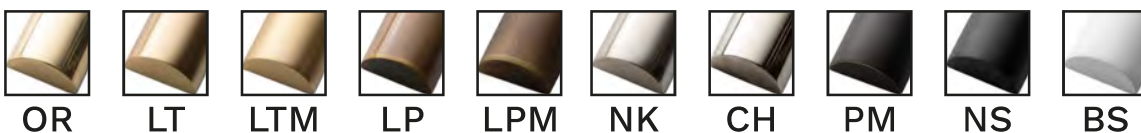

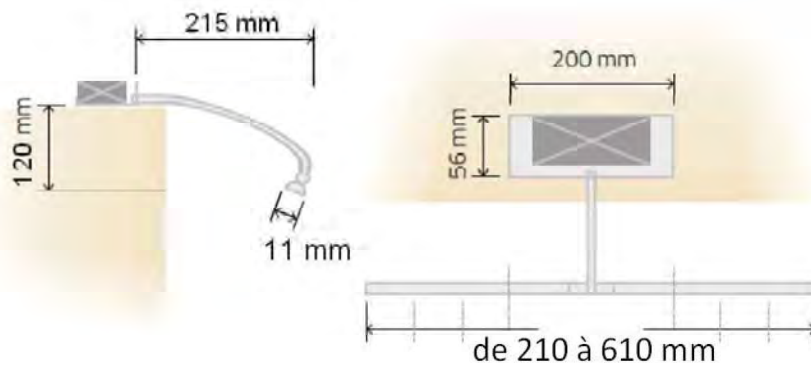
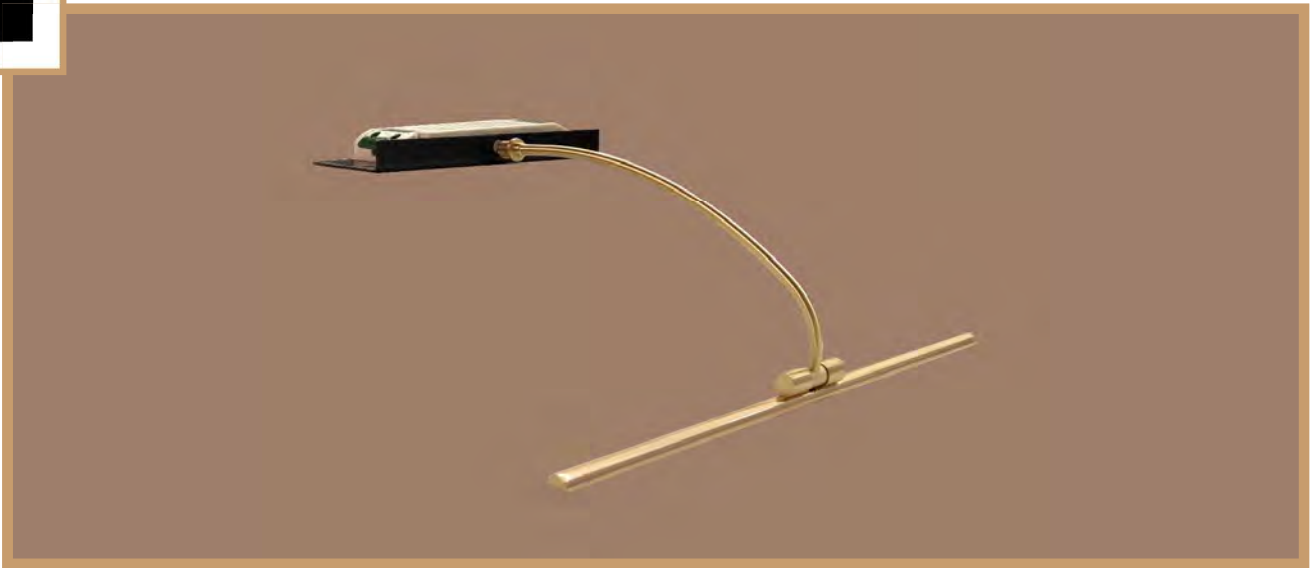

## Applique Tableaux bibliotheque Wall Picture Lamp for library

### W40 03

Disponible en 21, 31, 41, 51 et 61cm  
Available in 21, 31, 41, 51 et 61cm



details

Finitions disponibles / Available finishes

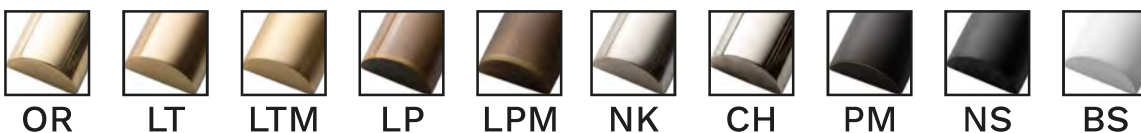



Eclairage Tableau  
Picture Lamp

W44 34

1W, 130lm

Nouveauté  
**MAISON & OBJET**  
NEW & NOW

Finitions disponibles / Available finishes



OR



LT



LTM



LP



LPM



NK



CH



PM



NS



BS

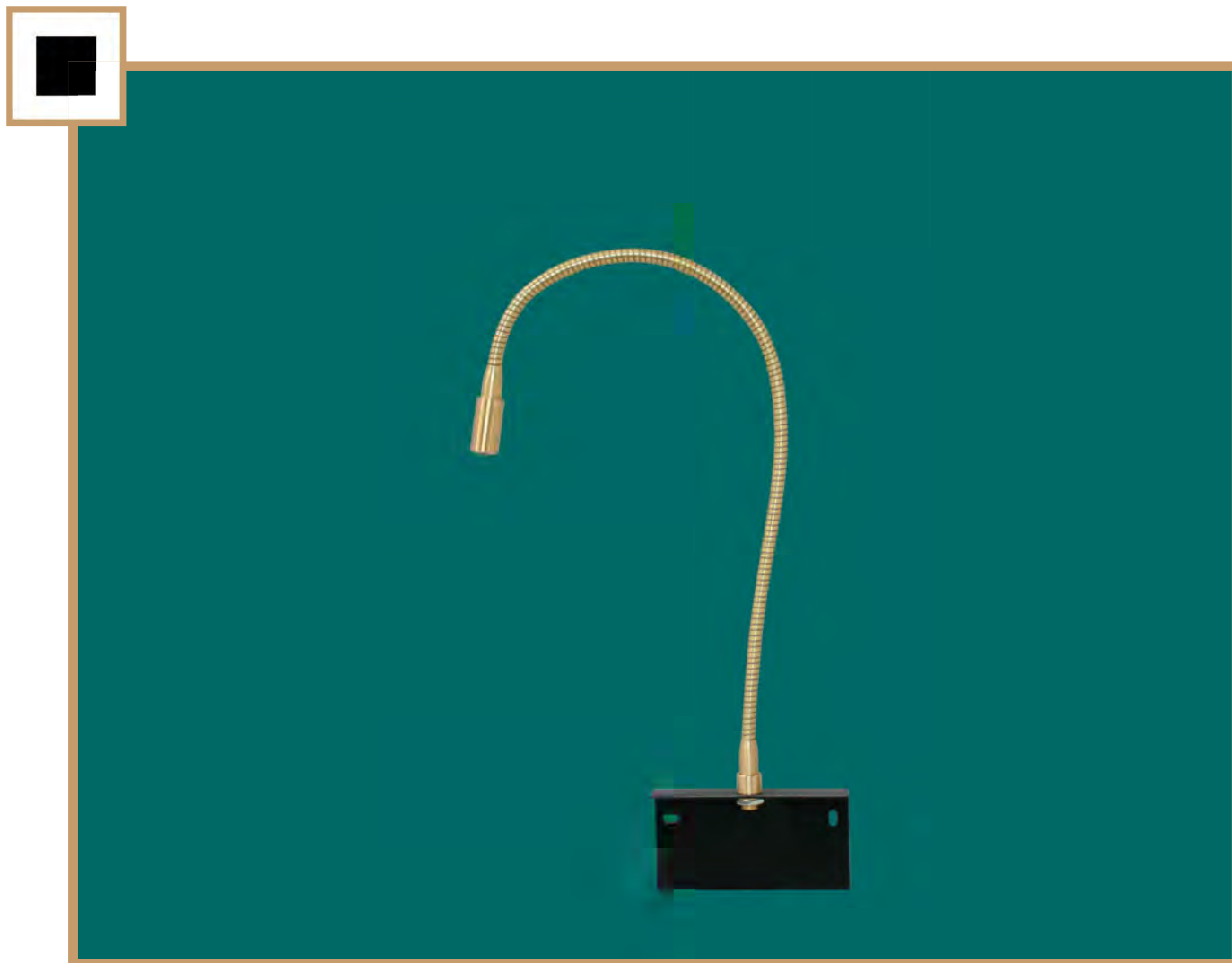

Eclairage Tableau  
Picture Lamp

W44 44

1W, 130lm

Nouveauté  
**MAISON&OBJET**  
NEW & NOW

Finitions disponibles / Available finishes



OR



LT



LTM



LP



LPM



NK



CH



PM



NS



BS



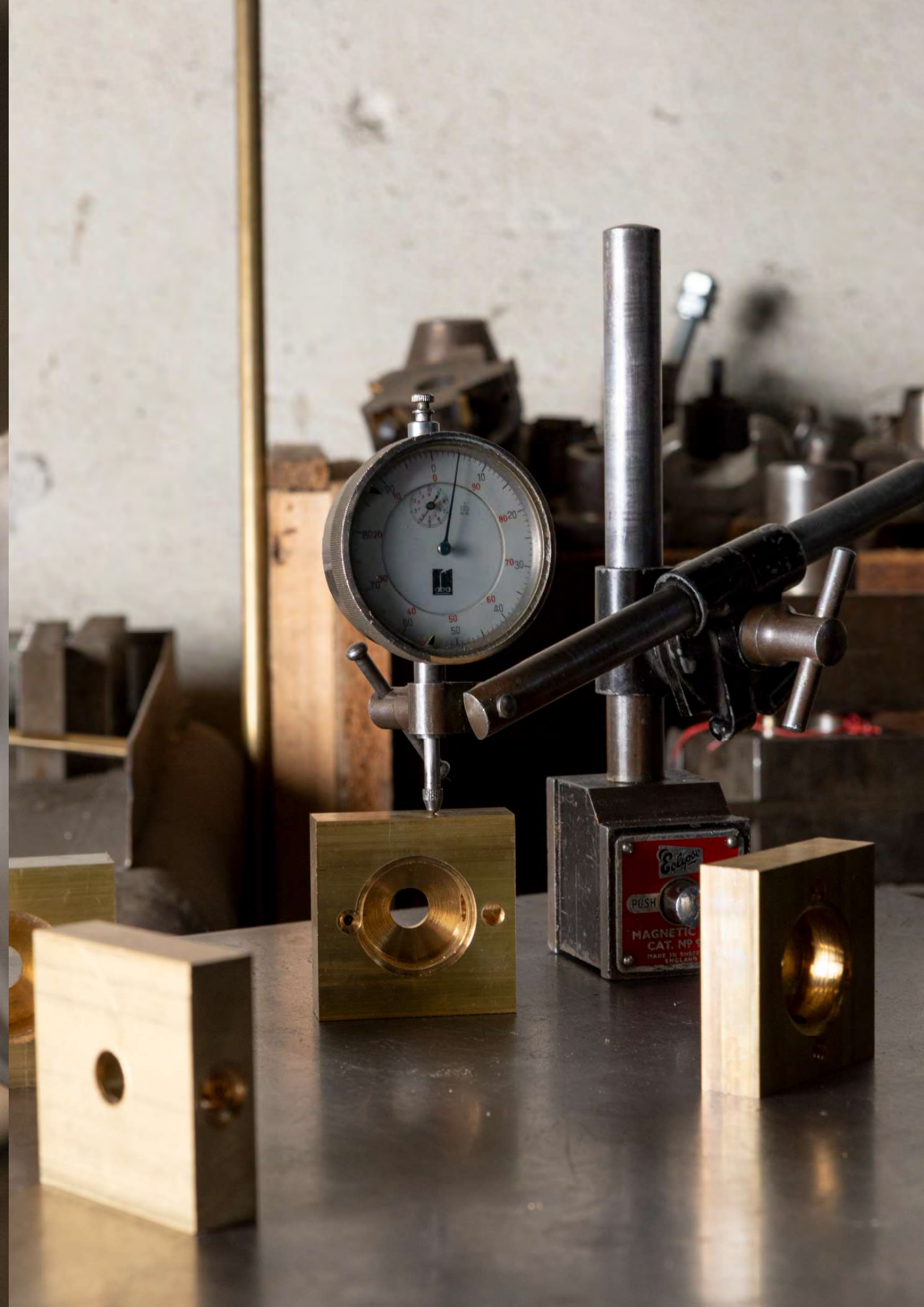

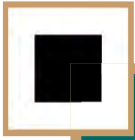

Spot à poser  
Table spotlight

**W64 01**

1.5W, 190lm

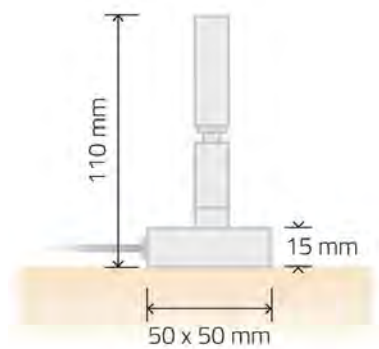

details

Finitions disponibles / Available finishes



OR



LT



LTM



LP



LPM



NK



CH



PM



NS



BS



Spot à poser  
Table spotlight

**W66 20**

1,5W, 190lm

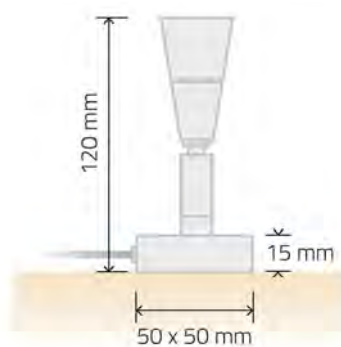

details

Finitions disponibles / Available finishes

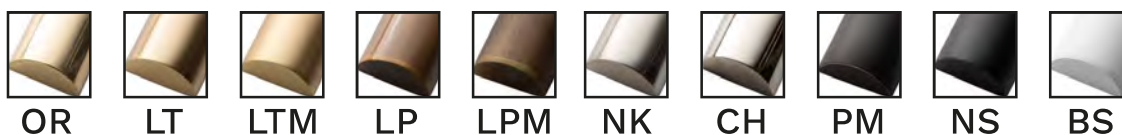

OR

LT

LTM

LP

LPM

NK

CH

PM

NS

BS

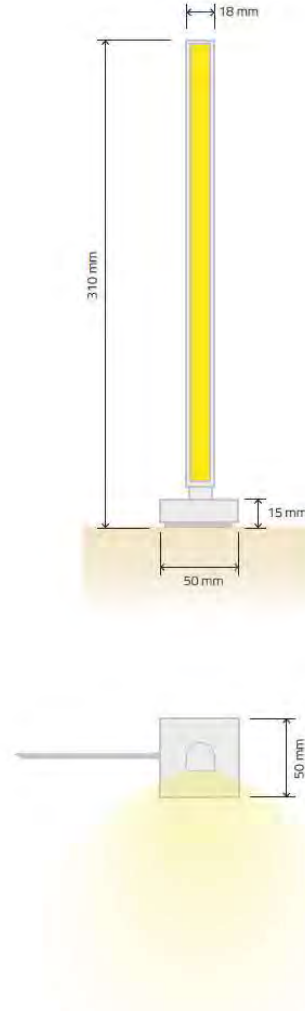
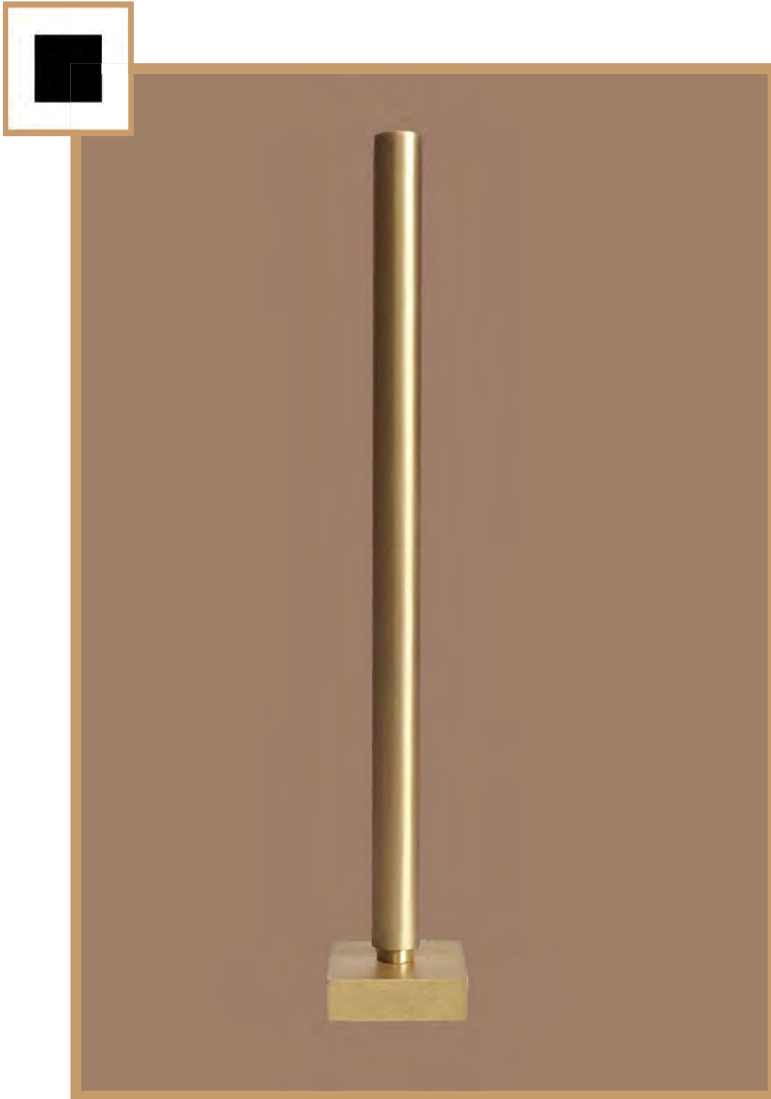

Spot à poser  
Table Spotlight

W69 01

2.7W, 400lm



details

Finitions disponibles / Available finishes

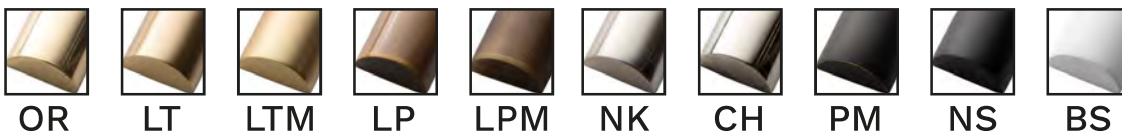

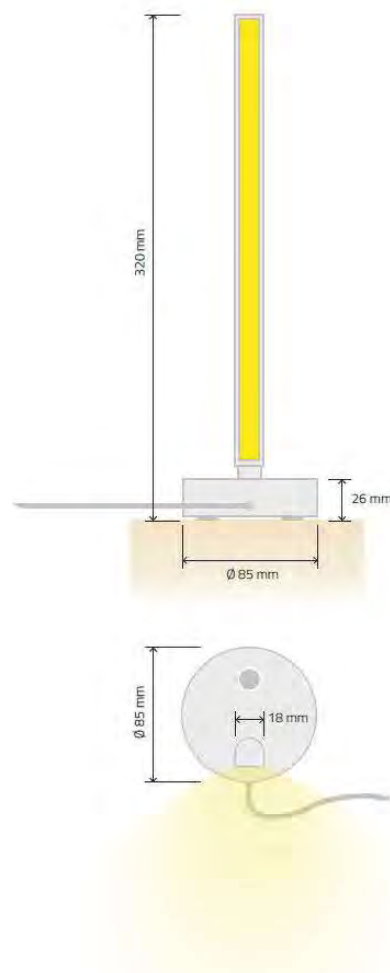

Spot à poser  
Table Spotlight

**W69 02**

2.7W, 400lm



details

Finitions disponibles / Available finishes

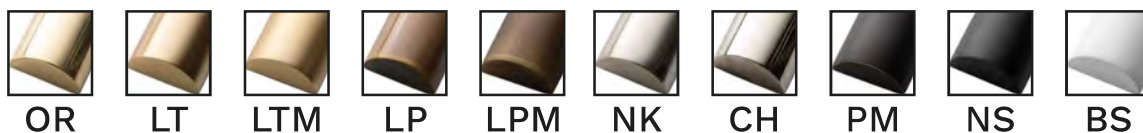



# COLLECTION POWER

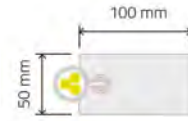

Spot à poser  
Table Spotlight

**W64 20**

3W, 360lm

Finitions disponibles / Available finishes

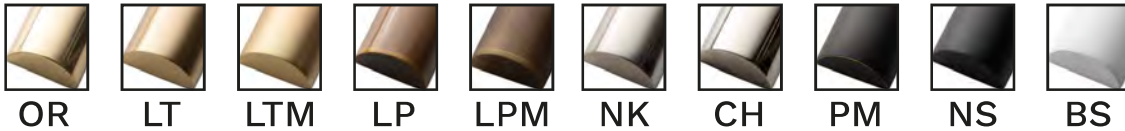

OR

LT

LTM

LP

LPM

NK

CH

PM

NS

BS

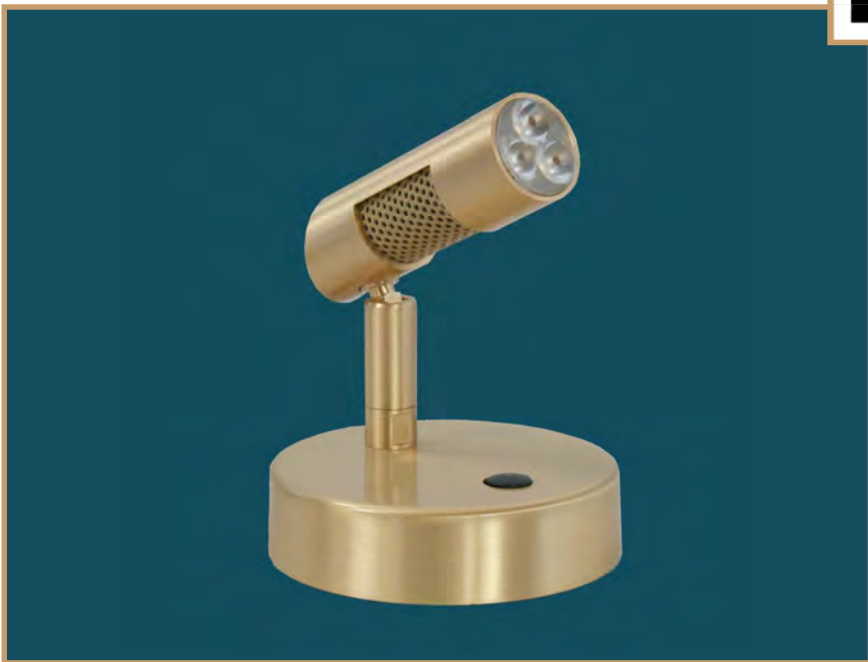

Spot à poser  
Table Spotlight

**W64 21**

3W, 360lm

Finitions disponibles / Available finishes

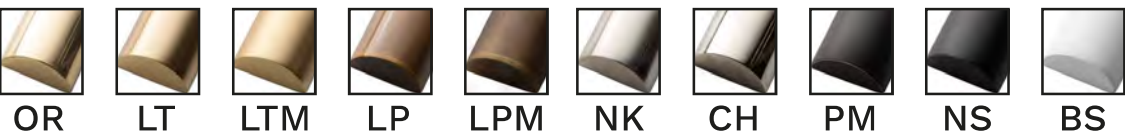

OR

LT

LTM

LP

LPM

NK

CH

PM

NS

BS



Spot à poser  
Table Spotlight

**W67 20**

7W, 820lm

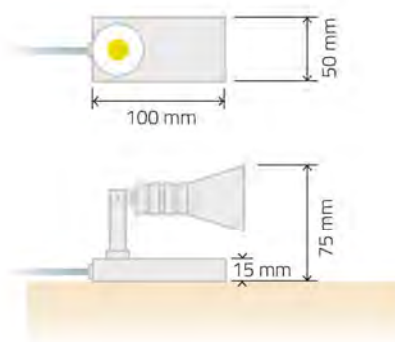

details

Finitions disponibles / Available finishes

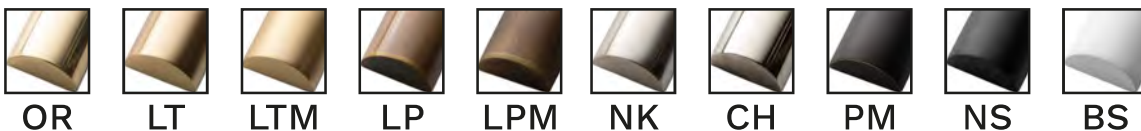

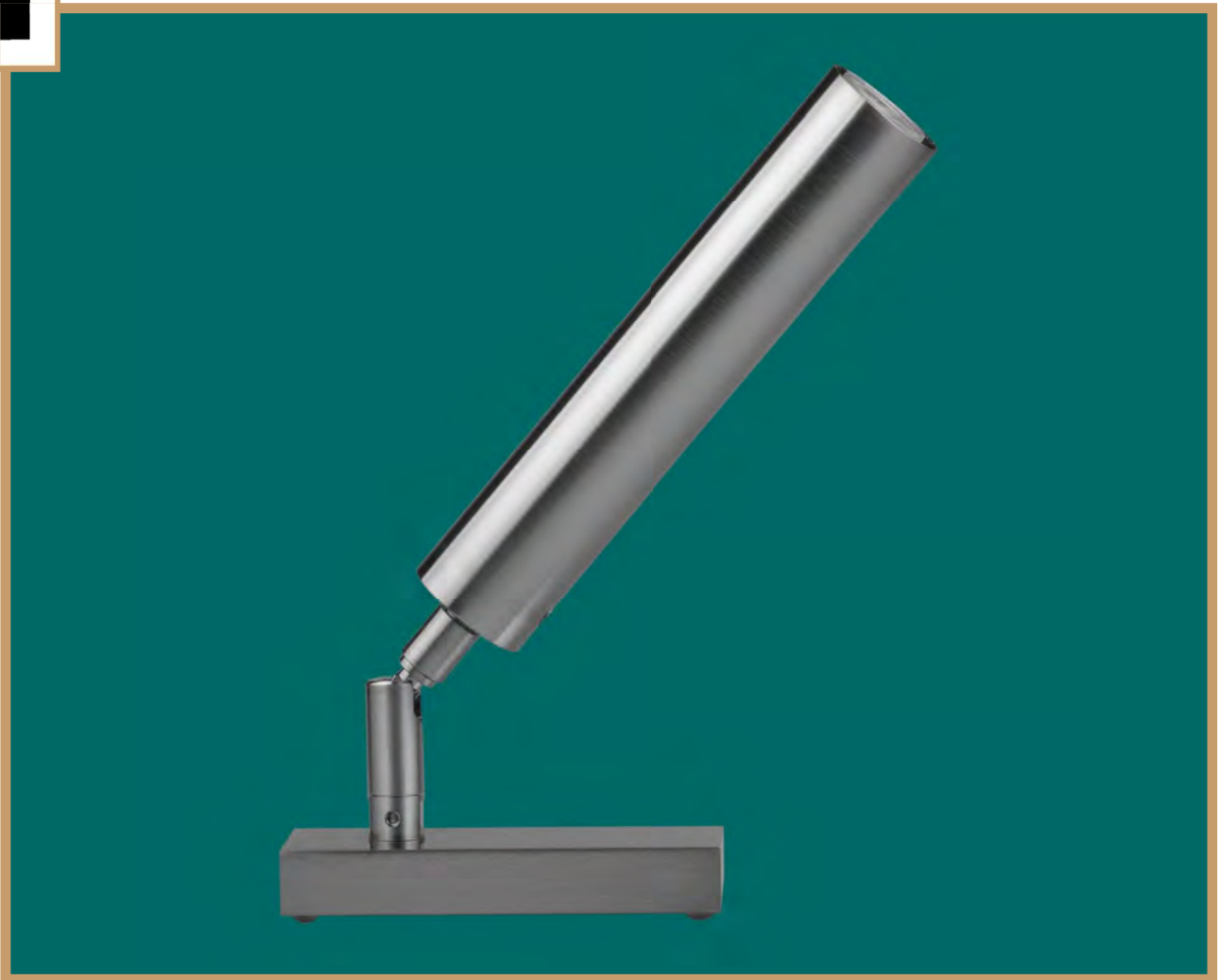
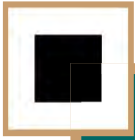

Spot à poser  
Table Spotlight

**W65 01**

3W, 360lm

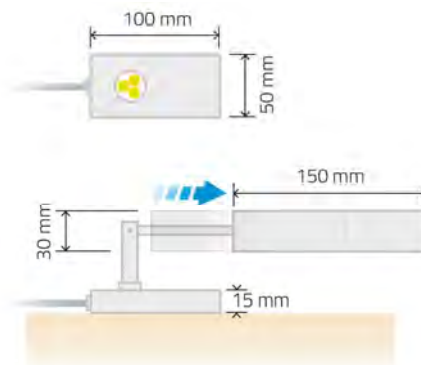

details

Finitions disponibles / Available finishes

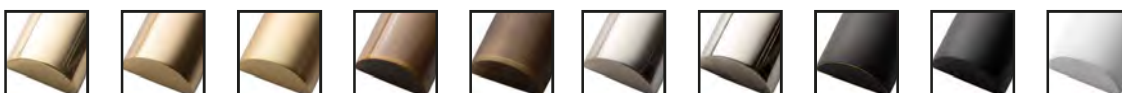

OR

LT

LTM

LP

LPM

NK

CH

PM

NS

BS





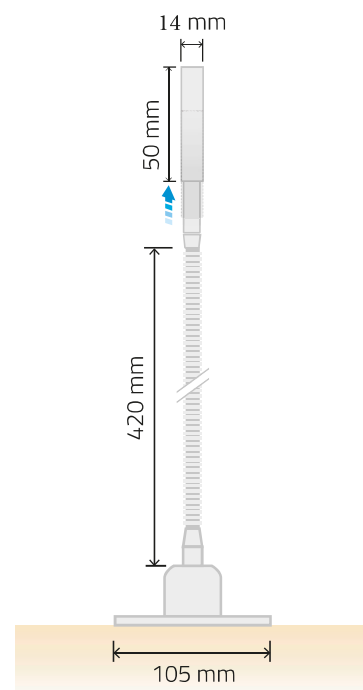

Lampe  
Lamp

## W67 30

1.5W, 190 lumens, 2700K, CRI>90,  
Optique ajustable 8 à 60°



details

Finitions disponibles / Available finishes

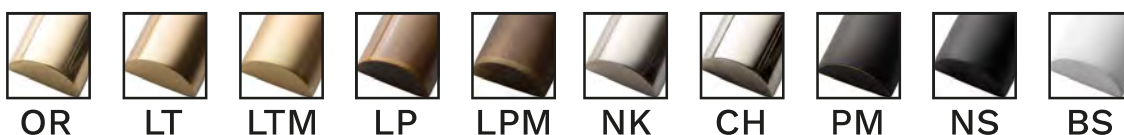

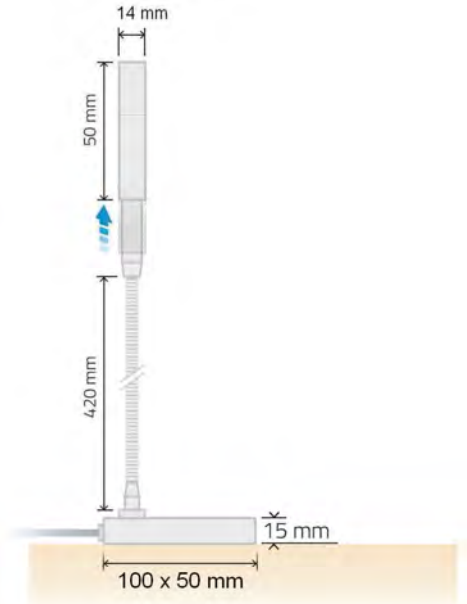

Lampe  
Lamp

## W67 31

1.5W, 190 lumens, 2700K, CRI>90,  
Optique ajustable 8 à 60°



details

Finitions disponibles / Available finishes

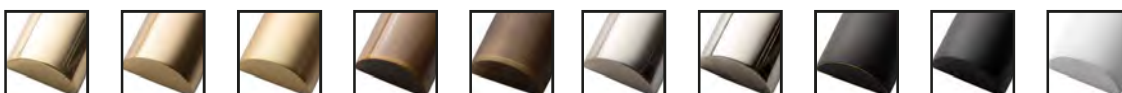

OR

LT

LTM

LP

LPM

NK

CH

PM

NS

BS





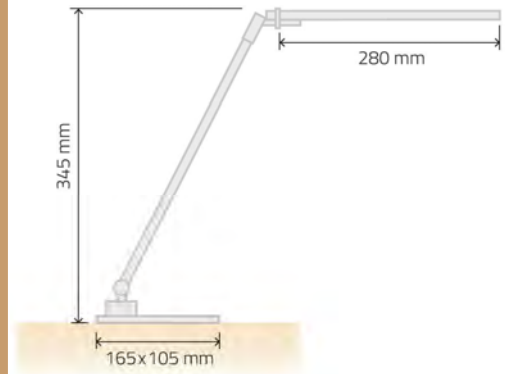

Lampe  
Lamp

## W62 32

6W, 600lm, CRI >98



details

Finitions disponibles / Available finishes



OR



LT



LTM



LP



LPM



NK



CH



PM



NS



BS



# COLLECTION EVOLIGHT

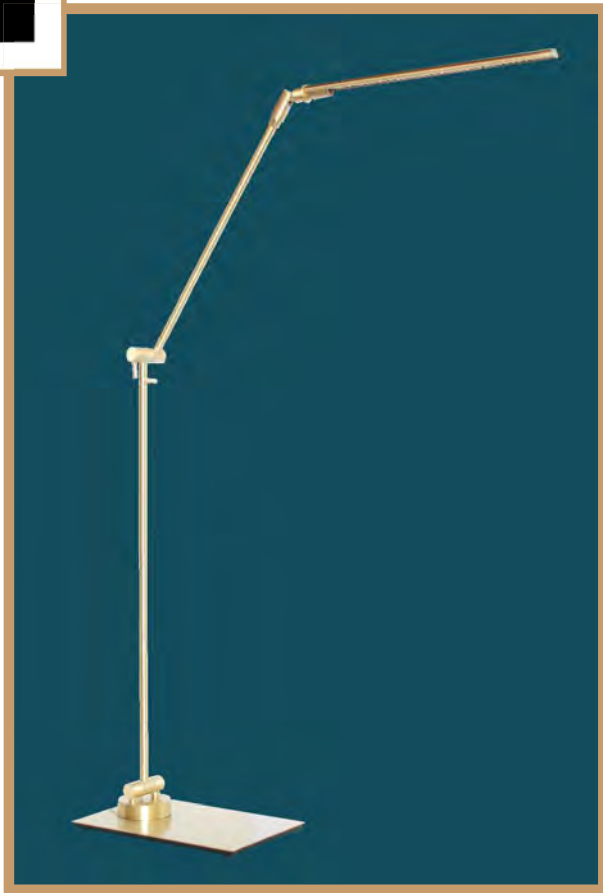

details

Lampe  
Lamp

W62 31

6W, 600lm, CRI >98



Finitions disponibles / Available finishes



OR



LT



LTM



LP



LPM



NK



CH



PM



NS



BS

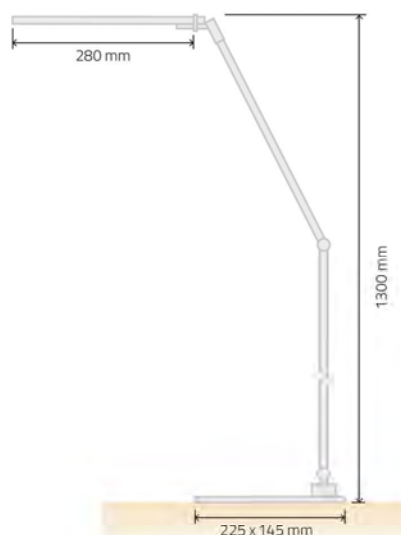
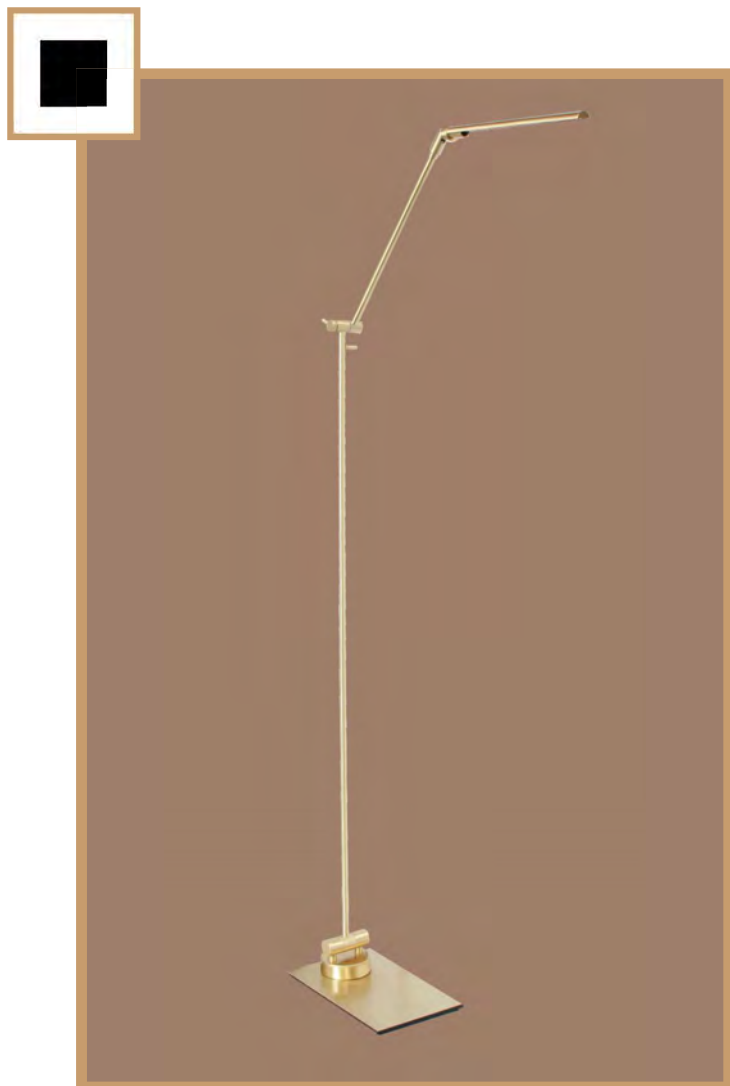

details

Lampadaire  
Floor Lamp

**W52 31**

6W, 600lm, CRI >98, Dimmable

Finitions disponibles / Available finishes

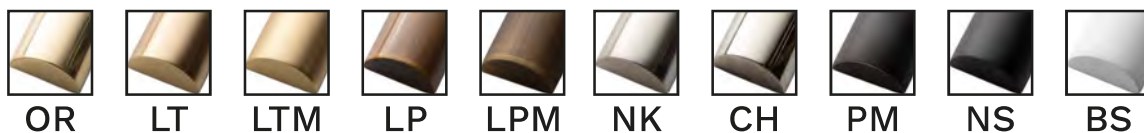

# COLLECTION INFINITY

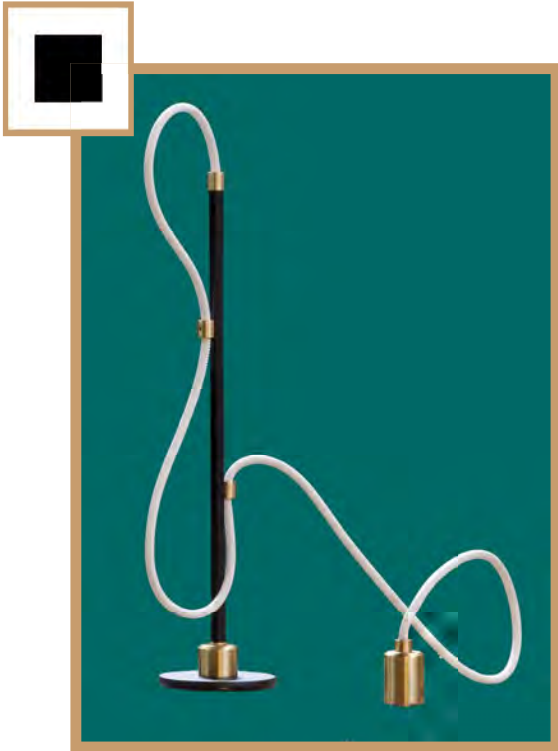

Lampe  
Table Lamp

I65 40

9W, 750lm

Nouveauté  
**MAISON&OBJET**  
NEW & NOW



details

Finitions disponibles / Available finishes

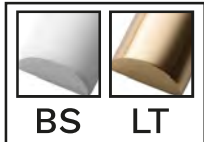

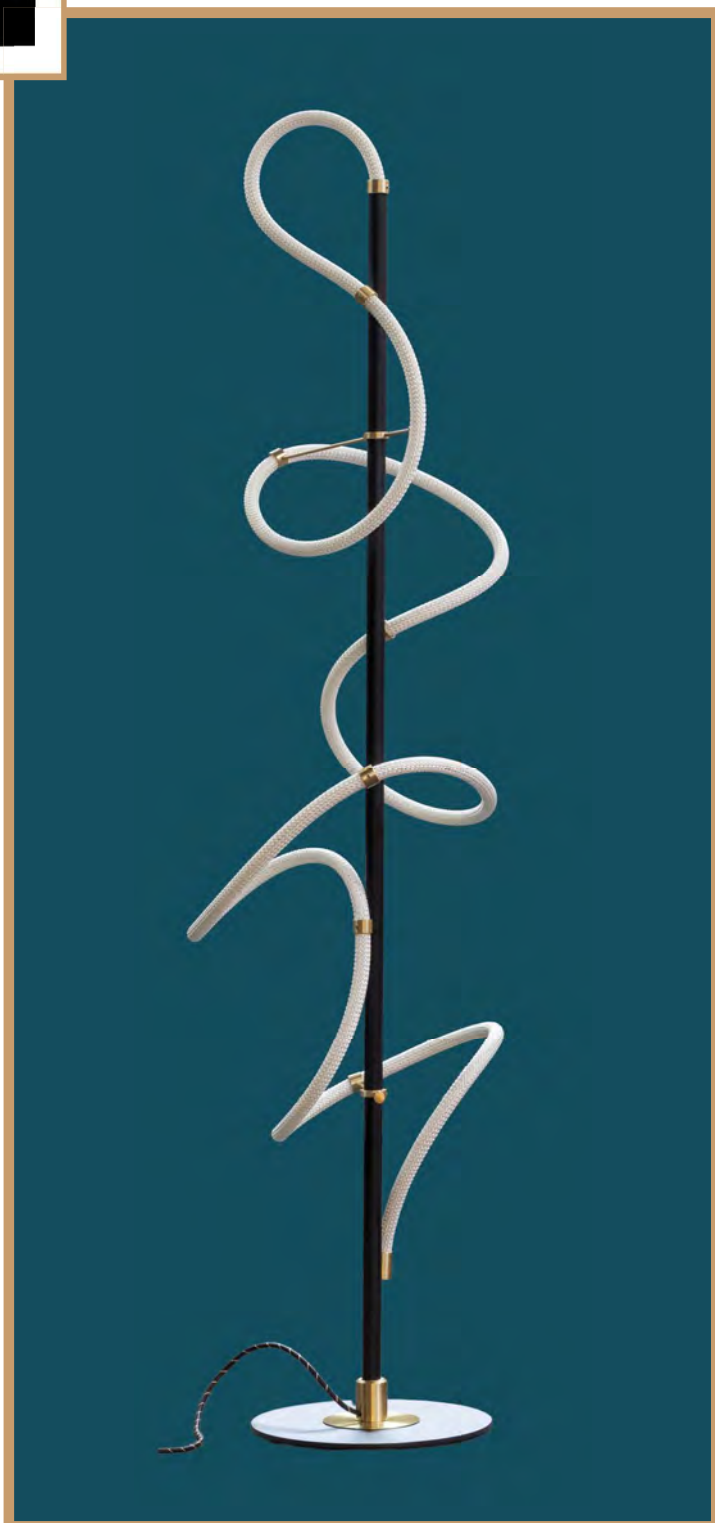

details

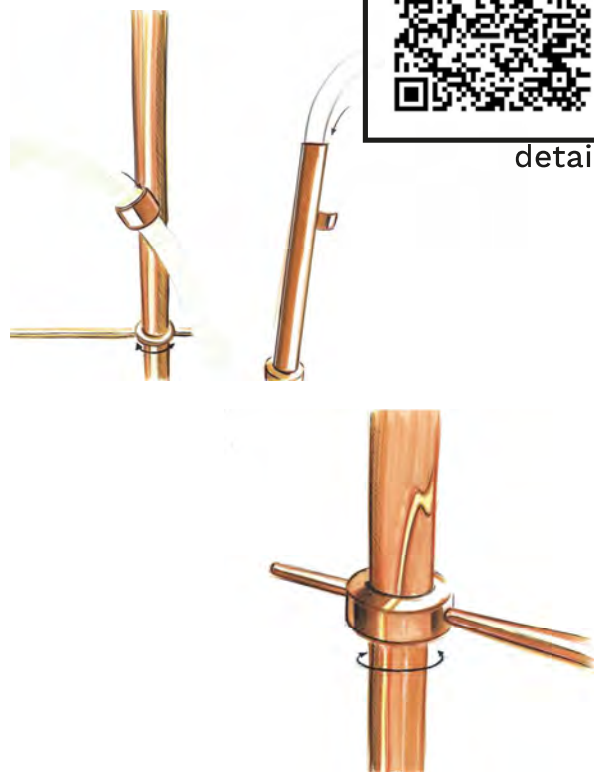

Nouveauté  
**MAISON & OBJET**  
NEW & NOW

Lampadaire  
Floor Lamp

**155 40**

40W, 2800lm, Dimmable

Finitions disponibles / Available finishes

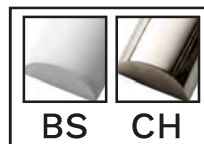
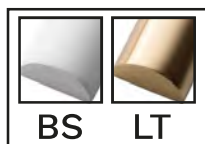
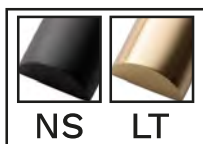

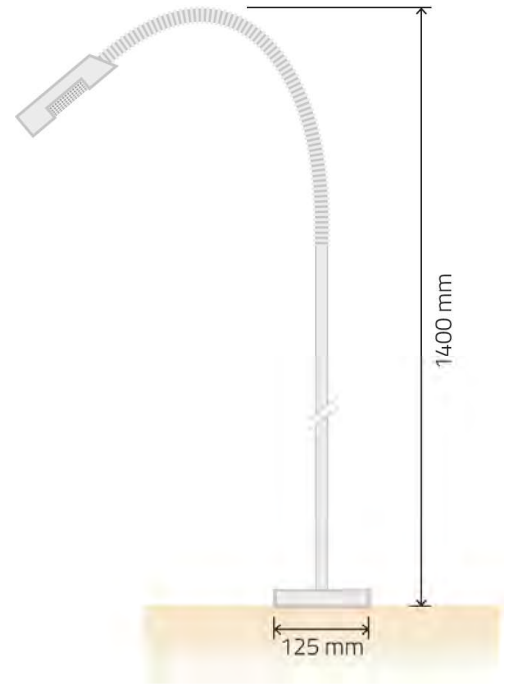
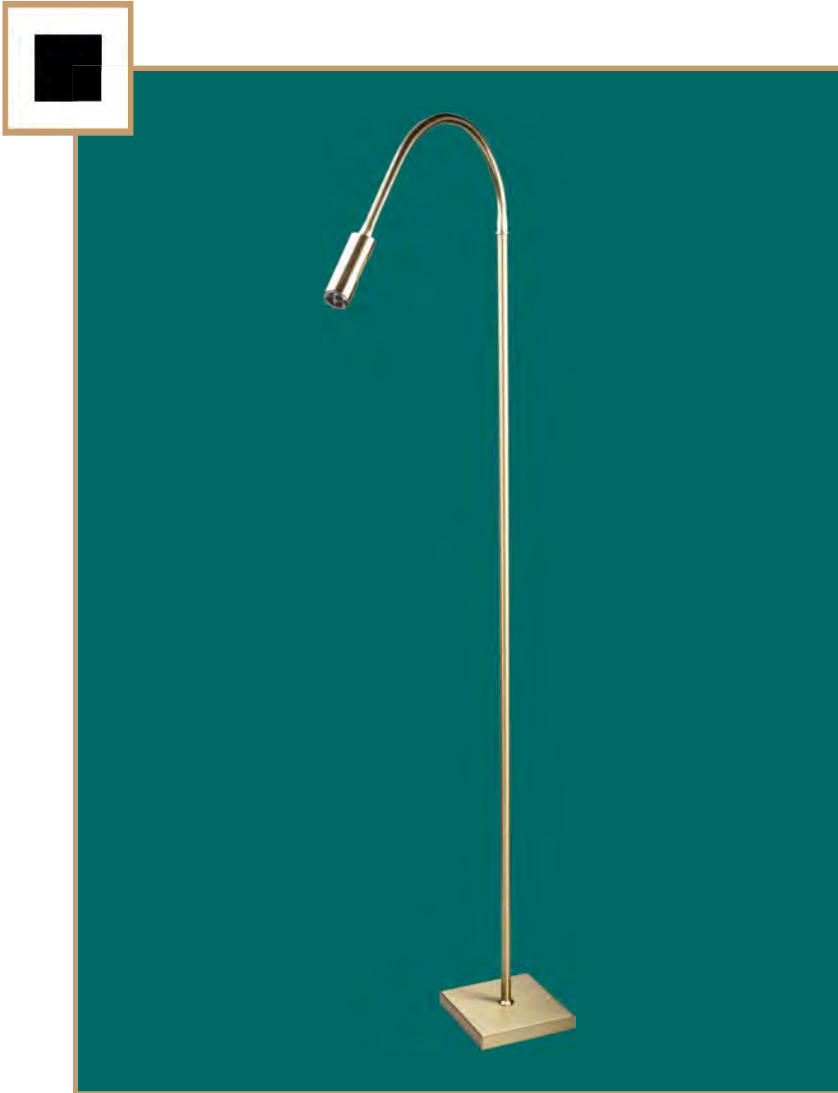

Lampadaire  
Floor Lamp

**W55 11**

3W, 360lm

Finitions disponibles / Available finishes

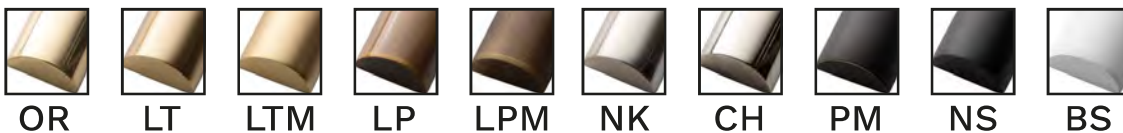

details







Lampe  
Lamp

Nouveauté  
**MAISON & OBJET**  
NEW & NOW

L65 40

---

12W, 960lm

---

Finitions disponibles / Available finishes

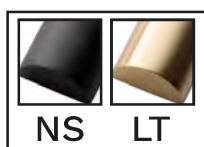

details

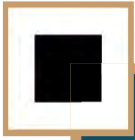

Lustre  
Chandelier

**I25 40**

50W, 3600lm, Dimmable

Nouveauté  
**MAISON&OBJET**  
NEW & NOW



details

Finitions disponibles / Available finishes

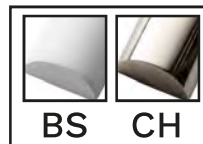
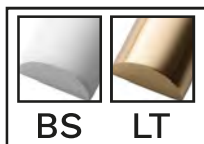
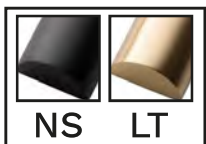





# COLLECTION BABY



Nouveauté  
**MAISON&OBJET**  
NEW&NOW

Semi-encastré  
Semi-recessed

**W04 30**

1.5W, 190lm

Finitions disponibles / Available finishes

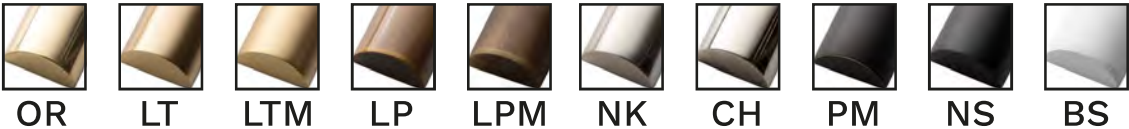

OR

LT

LTM

LP

LPM

NK

CH

PM

NS

BS



Nouveauté  
**MAISON&OBJET**  
NEW&NOW

Semi-encastré  
Semi-recessed

**W04 40**

1.5W, 190lm

Finitions disponibles / Available finishes

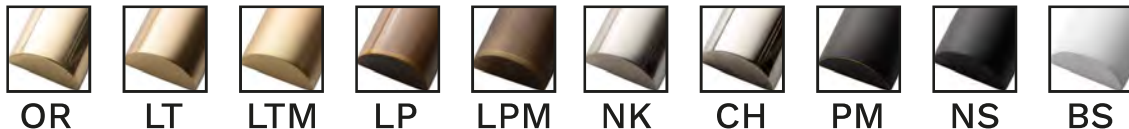

OR

LT

LTM

LP

LPM

NK

CH

PM

NS

BS

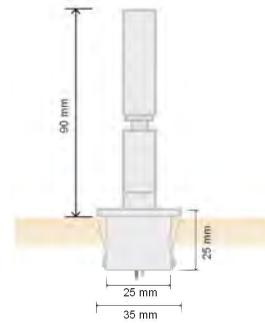

Semi-encasté  
Semi-recessed

**W04 01**

1.5W, 190lm

Finitions disponibles / Available finishes

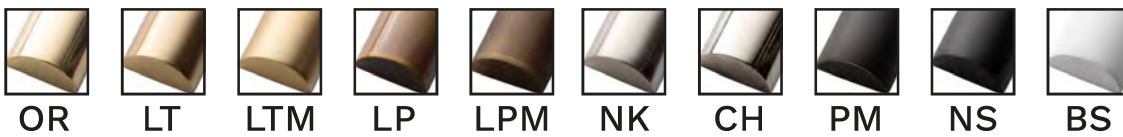

Semi-encasté  
Semi-recessed

**W06 20**

1.5W, 190lm

Finitions disponibles / Available finishes

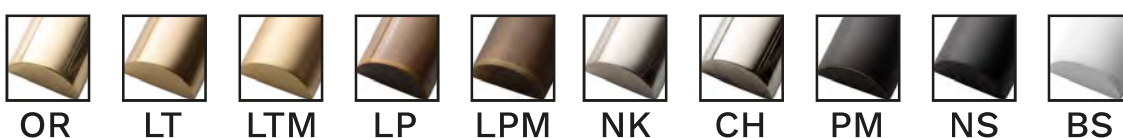

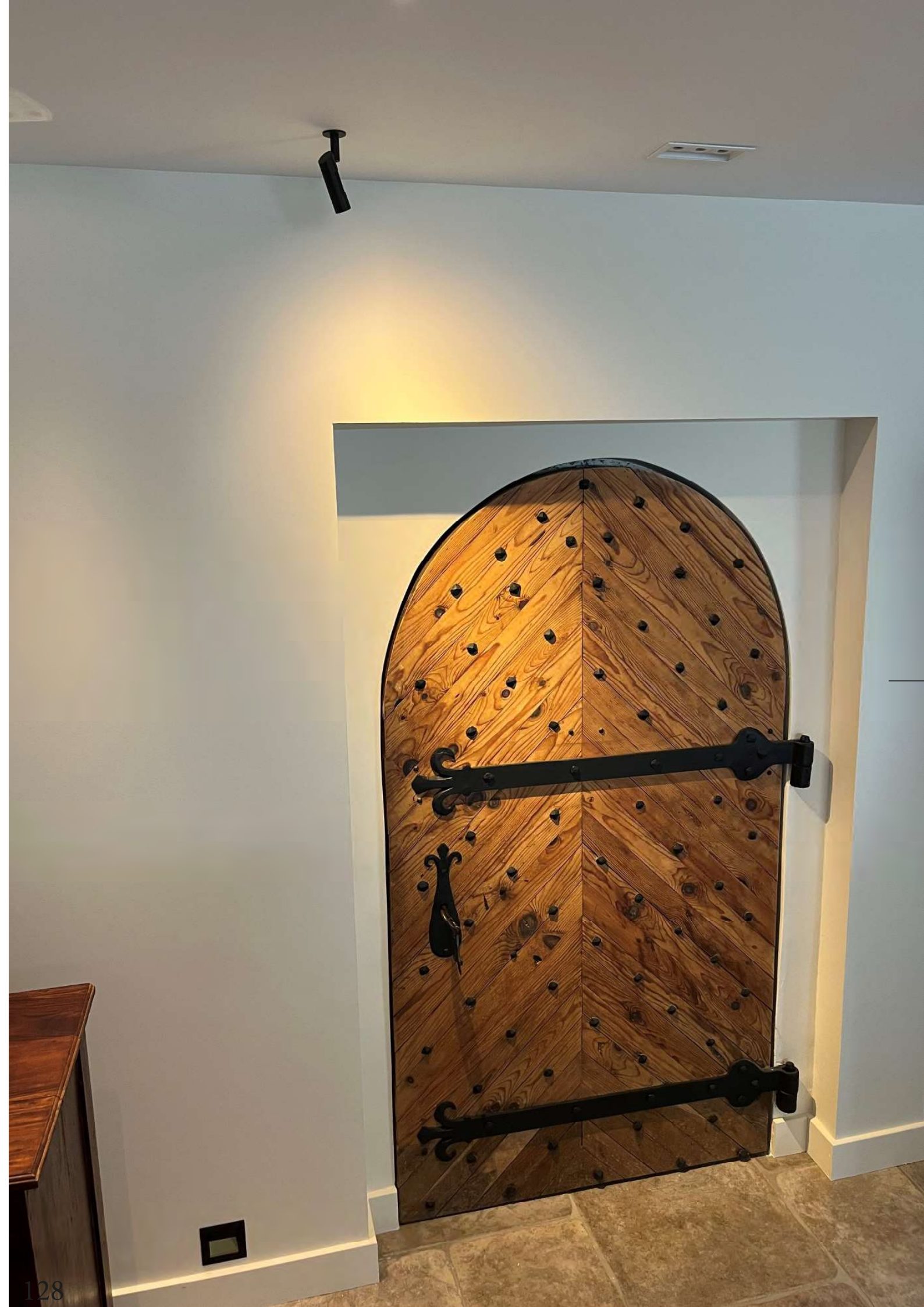

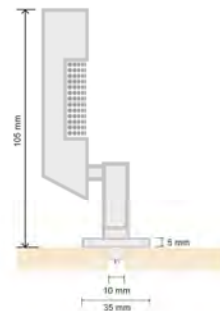

Semi-encasté  
Semi-recessed

**W05 20**

3W, 360lm

Finitions disponibles / Available finishes



OR



LT



LTM



LP



LPM



NK



CH



PM



NS



BS

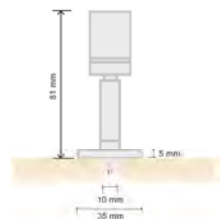
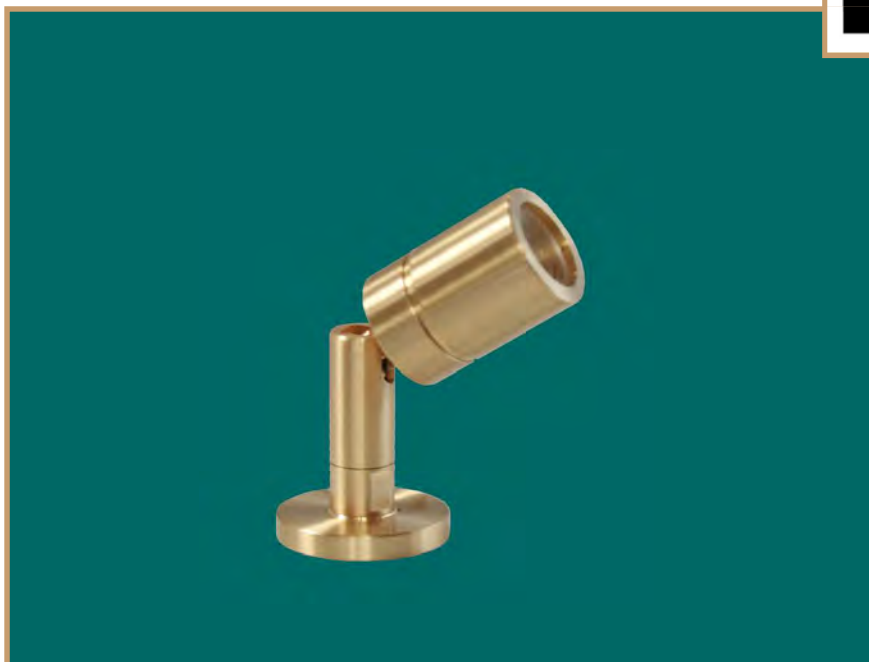

Semi-encasté  
Semi-recessed

**W04 20**

1.5W, 190lm

Finitions disponibles / Available finishes



OR



LT



LTM



LP



LPM



NK



CH



PM



NS



BS

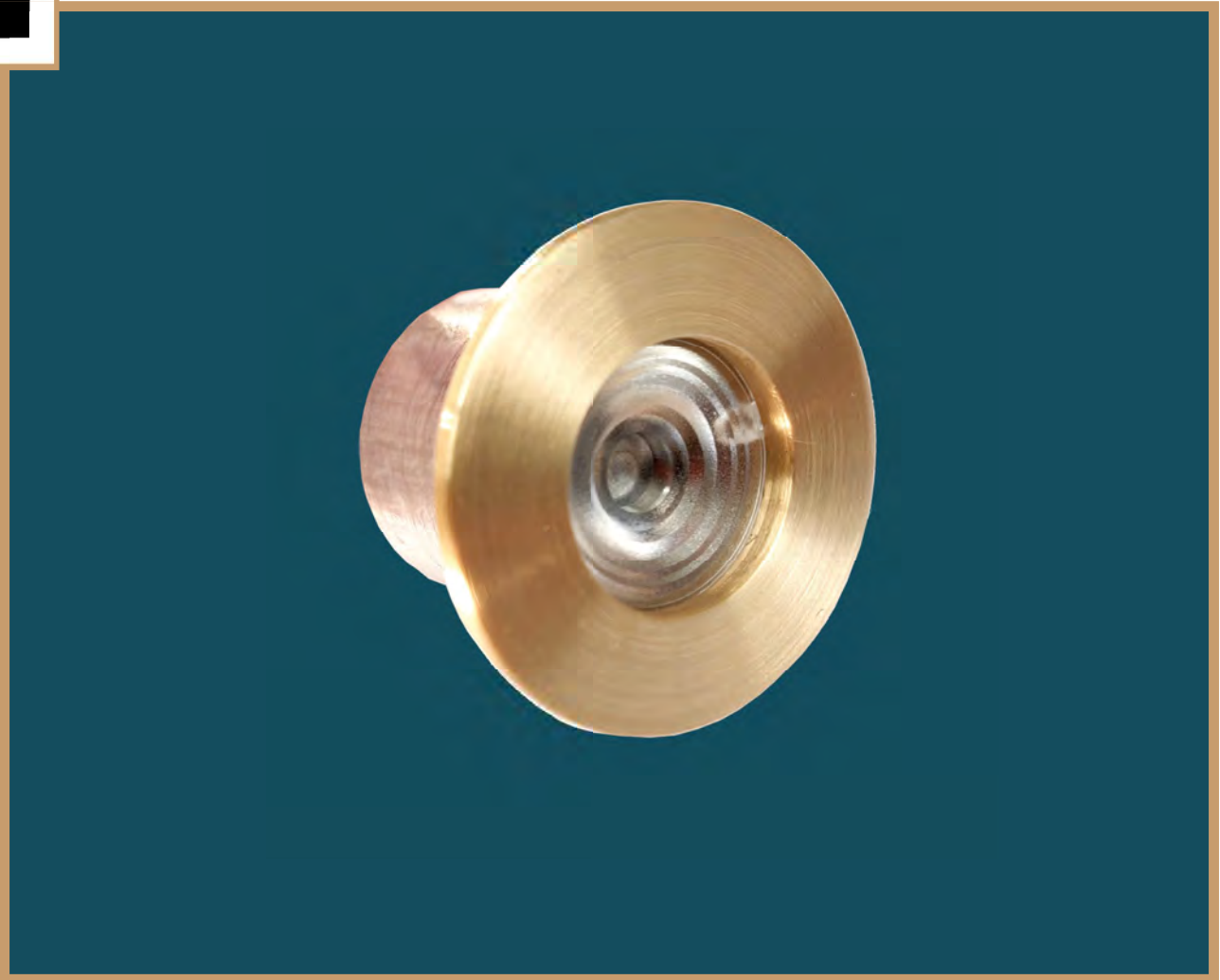

Encastré  
Recessed Spotlight

## W.MONO

1.5W, 190lm



details

Finitions disponibles / Available finishes



OR



LT



LTM



LP



LPM



NK



CH



PM



NS



BS

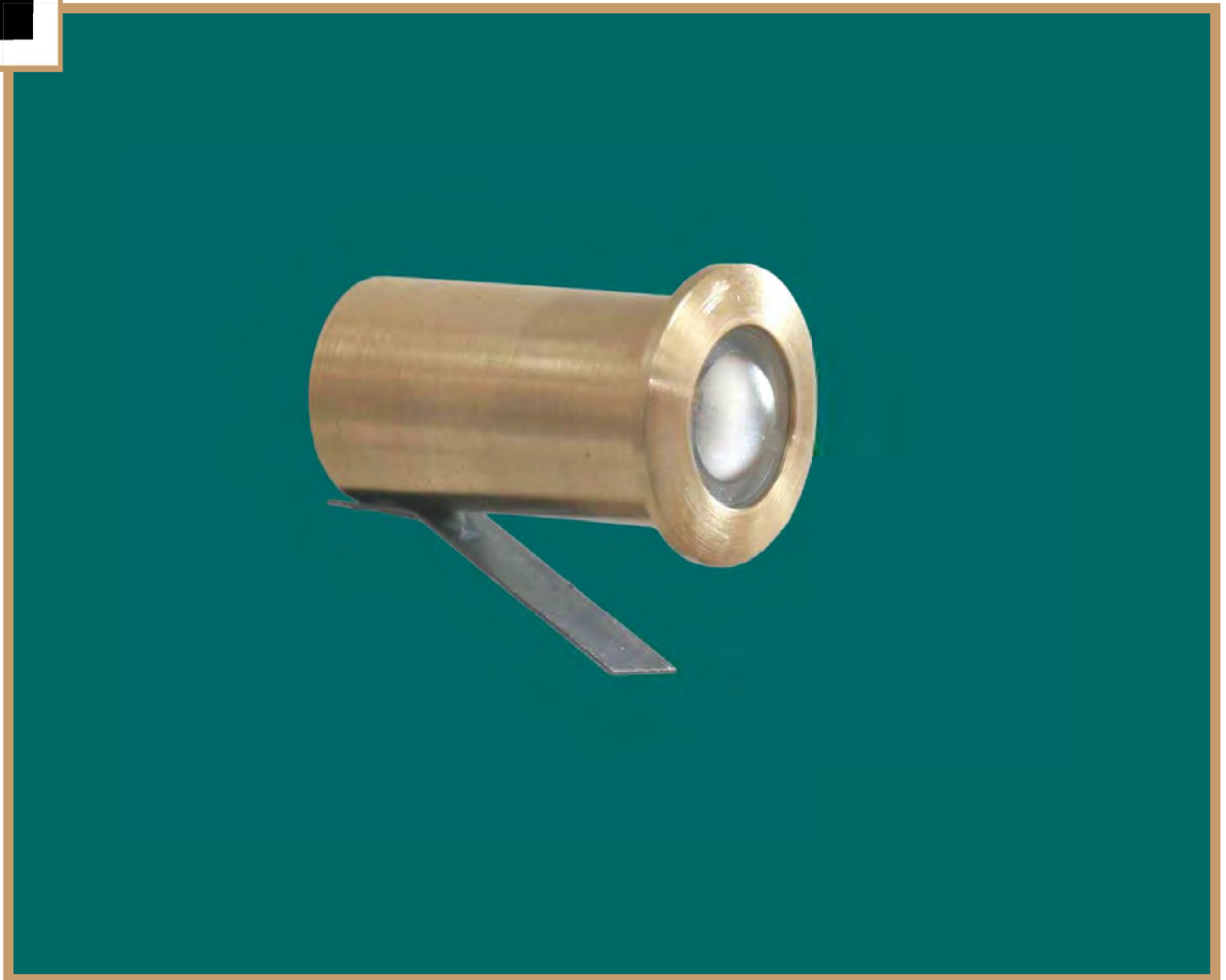
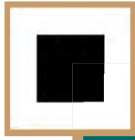

Spot à poser  
Table Spotlight

**W.MICRO**

1W, 130lm

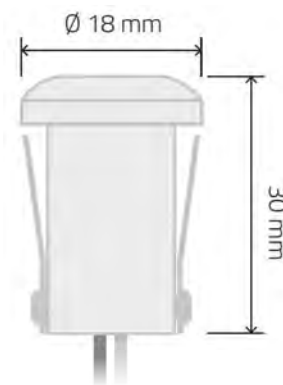

details

Finitions disponibles / Available finishes

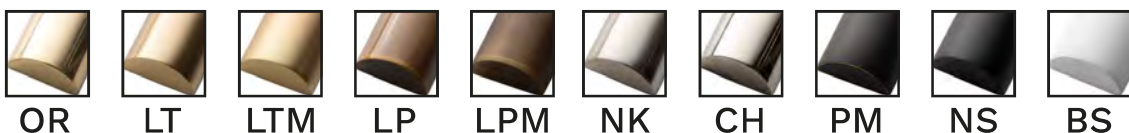

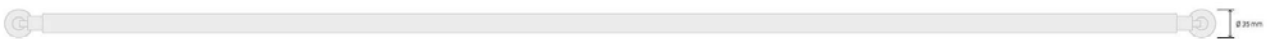
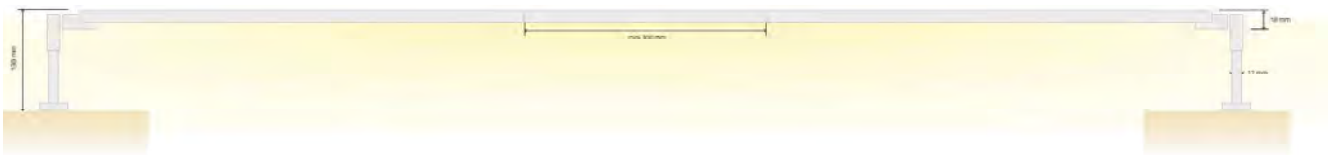

Arche

W49 20

Disponible de 30 à 150cm  
Available from 30 to 150cm



details

Finitions disponibles / Available finishes



OR



LT



LTM



LP



LPM



NK



CH



PM



NS



BS

















# CONDITIONS GÉNÉRALES DE VENTE

## 1. Offres et Devis

À tout moment et sans préavis, les informations portées sur les catalogues, notices ou barèmes, peuvent être modifiées en raison de l'évolution de la technique ou des conditions économiques. La validité des offres et devis de la société TEKNI-LED est limitée à 1 mois

## 2. Prix

Les prix applicables sont ceux mentionnés dans les barèmes, l'offre ou le devis en vigueur à la date de la passation de la commande. Les prix indiqués sont toujours hors taxes.

Ils ne tiennent pas compte pour les lampes de l'incidence des coûts écoulant des obligations édictées par le décret n°2005-829 du 20 juillet 2005 relatif aux déchets d'Équipements Electriques et Electroniques (EEE). Les prix de vente des EEE sont donc sujets à révision en cours d'année.

## 3. Commande

Toute commande emporte l'acceptation immédiate, pleine et entière, sans réserve d'aucune sorte, par l'Acheteur des présentes conditions de vente et renonciation de sa part à ses propres conditions générales d'achat. Les présentes conditions de vente constituent ainsi, seules, la loi des parties pour l'exécution de la commande et ce à l'exclusion de tout autre document quel qu'il soit à l'exception toutefois, le cas échéant, de conditions particulières convenues d'un commun accord par écrit

La société TEKNI-LED se réserve le droit d'apporter sans préavis toutes modifications à ses produits sans avoir pour autant l'obligation de modifier pareillement les produits déjà livrés ou restant à livrer.

Si les produits ont déjà été expédiés, aucune annulation de commande n'est prise en compte. Pour tous les autres produits, l'Acheteur a la faculté d'annuler sa commande sans pénalité sous réserve de notifier sa décision par écrit à la société TEKNI-LED dans un délai maximal de trois (3) jours (T+3) à compter du jour de la passation de sa commande (T) En cas de non-respect de ce préavis, aucune annulation de commande n'est prise en compte

L'Acheteur ayant la connaissance de l'usage auquel il destine les produits ainsi que leurs conditions d'utilisation et, par ailleurs, les catalogues et notices techniques de la société TEKNI-LED ne pouvant être exhaustifs compte tenu notamment de la diversité des cas d'utilisation et de la grande diffusion des produits, l'Acheteur reconnaît qu'il lui appartient préalablement à sa commande de vérifier, seul ou avec ses propres clients, l'adéquation des produits à l'usage qu'il entend en faire.

## 4. Livraisons

Les commandes peuvent être exécutées en une ou plusieurs livraisons. Les délais de livraison sont donnés à titre indicatif.

### a) Emballage

Sauf demande particulière à la charge de l'Acheteur, l'emballage des produits est standard et fonction de leurs natures et du mode usuel de transport.

### b) Transport

Nos expéditions bénéficient du franco de port et d'emballage pour toute commande unitaire à livrer en France Métropolitaine, d'au moins 400 euros hors TVA. Pour toute commande inférieure à ce seuil, une participation forfaitaire correspondant à une quote-part des frais de reconditionnement sera facturée. Ce montant, dépendant du poids de l'expédition se monte à environ 15 euros hors TVA.

Les produits voyagent aux risques et périls de l'acheteur auquel il appartient de vérifier les expéditions à l'arrivée quel que soit le lieu de livraison, de faire état des réserves éventuelles et d'exercer les réclamations auprès du dernier transporteur par LRAR dans les 3 jours ouvrables suivant la livraison, même si l'expédition a été faite franco. Les transports, franco de port et d'emballage, entendent toujours déchargement par le destinataire, le chauffeur ne pouvant opérer seul. Il appartient à l'Acheteur de communiquer à la commande ou au plus tard 10 jours avant la livraison, l'adresse exacte et précise du lieu de livraison ainsi que les contraintes particulières qui peuvent exister, tels les horaires de réception, la livraison en sous-sol ou en étage, la limitation de gabarit ou de poids. L'Acheteur devra réunir les conditions nécessaires à la réception et au déchargement des produits en tenant compte de leurs spécificités, notamment pour les produits de grande longueur. Tout frais additionnel de transport dit de l'Acheteur (par exemple en cas d'erreur d'adresse de livraison, d'absence du destinataire ou d'informations relatives aux contraintes particulières insuffisantes) lui sera automatiquement facturé au coût réel. L'Acheteur devra organiser la réception des produits notamment en cas de chantier. Tout retour en cas d'impossibilité de livraison est à sa charge y compris les frais de stockage et de nouvelle livraison

### c) Réclamation

Pour être prise en compte, toute réclamation touchant à la nature, au type, aux caractéristiques, aux bordereaux de livraison et à la qualité apparente des produits devra nous être signalée par écrit avec accusé de réception dans un délai de 3 jours à compter de la livraison

## 5. Facturation - Paiements

La livraison même partielle constitue le fait générateur de la facturation dont le règlement s'effectue selon les modalités de paiement indiquées ci-après

Le paiement est effectué au lieu mentionné sur la facture L'Acheteur est rempli de son obligation de paiement une fois que la somme due est effectivement encaissée par la

société TEKNI-LED, la simple remise du titre de paiement étant insuffisante. L'Acheteur ne peut jamais procéder à des compensations quel qu'en soit la raison.

Toute contestation d'une facture ou d'un avoir est à faire dans les 8 jours de sa réception. Les avoirs sont compensés à réciprocité d'échéance.

Le délai de paiement des factures est fixé en accord avec le client. La facture mentionne la date de règlement.

En cas de paiement anticipé, aucun escompte n'est accordé.

Retard de règlement :

Tout retard de paiement par rapport à la date de règlement donne lieu de plein droit à une pénalité de retard calculée par application aux sommes restant dues d'un taux égal au taux d'intérêt appliqué par la BCE à son opération de refinancement la plus récente majoré de sept points de pourcentage sans que cette pénalité nuise à l'exigibilité de la dette. Les pénalités de retard seront payables à réception de l'avis informant l'acheteur qu'elles sont portées à son débit En cas de contestation ou d'exécution partielle du contrat, le paiement demeure exigible sur la partie du contrat non contestée ou partiellement exécutée. La société TEKNI-LED aura également la faculté de déclarer résolue de plein droit la vente de tout ou partie des produits dont le prix n'a pas été entièrement payé

## 6. Réserve de Propriété

La société TEKNI-LED conserve la propriété des matériels vendus jusqu'au paiement effectif de l'intégralité du prix en principal et accessoires Le défaut de paiement de l'une quelconque des échéances pourra entraîner la revendication de ces matériels. L'Acheteur assume, néanmoins, à compter de la livraison, les risques de perte ou de détérioration de ces matériels ainsi que la responsabilité des dommages qu'ils pourraient occasionner. Aucune dérogation à cette clause ne peut être acceptée

L'Acheteur ne devra pas altérer ou supprimer les signes d'identification de ces matériels et de leurs emballages, dont ils autorisent la vérification à tout moment dans leurs stocks

## 7. Retours

Hormis le cas de faute ou d'erreur imputable à la société TEKNI-LED :

- Aucun retour de produit fabriqué Sur Commande n'est accepté,

Pour les produits Dispo, tout retour est subordonné (i) aux conditions cumulatives suivantes :

- Le montant des produits concernés est égal ou supérieur à 150 euros hors taxes,

Les produits sont en parfait état dans leur emballage d'origine,

- Les produits sont tenus, par l'Acheteur, à la disposition de la société TEKNI-LED, dans ses locaux de Vienne après accord de reprise adressé à l'acheteur par la société TEKNI-LED.

Et (2) à une acceptation préalable écrite de la société TEKNI-LED.

Le montant de l'avoir correspondant aux produits repris est limité à 70% de leur montant facturé (hors taxes).

## 8. Garantie

a) la société TEKNI-LED garantit, pendant une période de 12 mois à compter de la date de livraison, la conformité des produits aux spécifications de la société TEKNI-LED et à l'état des connaissances techniques du moment. En conséquence, tout vice de fonctionnement provenant d'un défaut de conception, de matière ou de fabrication donne droit, dans un délai raisonnable et au choix de la société TEKNI-LED, à l'échange ou à la réparation des produits reconnus défectueux.

b) Le coût et les risques de transport des produits concernés ainsi que les frais de démontage et de remontage sont à la charge de l'Acheteur. Les frais de réparation sur place (personnel, séjour et matériel) sont à la charge de l'Acheteur.

c) La garantie ne couvre pas les défauts qui proviendraient du non-respect des prescriptions d'installation, d'utilisation et d'entretien ou du non-respect du ou des normes applicables ou de l'état de l'art, d'une cause étrangère au produit (mauvaise installation électrique, surtension, foudre etc), de tout usage anormal ou de toute modification ou intervention de l'Acheteur ou d'un tiers. La garantie n'est pas applicable à l'usure normale résultant des caractéristiques physiques inhérentes aux lampes dont les performances sont fonction du temps d'utilisation. En outre, la fin de vie naturelle d'un produit pendant le délai de garantie, n'est pas une non-conformité et ne bénéficie donc pas des termes du présent article

La garantie ne s'applique pas en cas de défectuosité résultant des instructions données par l'Acheteur à la société TEKNI-LED

d) Pour bénéficier de la garantie, l'acheteur doit :

- Aviser par écrit la société TEKNI-LED des défauts qu'il impute au produit dès manifestation de ces défauts et au plus tard dans un délai de 1 mois

Fournir un descriptif détaillé du défaut avancé et des conditions d'emploi des produits ainsi que, sur demande de la société TEKNI-LED, des échantillons.

S'abstenir, sauf accord écrit de la société TEKNI-LED, d'effectuer lui-même ou de faire effectuer, la réparation.

Restituer, sur demande de la société TEKNI-LED, les produits remplacés au titre de la garantie

La Garantie est applicable - directement et seulement - Au bénéfice de l'Acheteur de la société TEKNI-LED et ne s'étend

pas aux revendeurs, agents ou autres représentants de l'Acheteur ni à ses propres clients.

En cas de demande abusive d'application de la garantie, la société TEKNI-LED se réserve la faculté de facturer les frais encourus à l'Acheteur.

- La garantie ne s'applique pas aux installations destinées à usage militaire, aéronautique ou médical. Dans ces 3 secteurs une autorisation préalable devra être requise.

Les produits remplacés au titre de la présente garantie sont eux-mêmes garantis pour la durée restant à courir au titre de la garantie initiale. La programmation d'un système de pilotage d'éclairage est sous la responsabilité du client et exclusive de toute garantie. Toute prestation d'assistance technique de la part de la société TEKNI-LED fait l'objet d'un devis et d'une facturation au client.

## 9. Responsabilité

La responsabilité de la société TEKNI-LED relative à toute réclamation au titre de la garantie et à tout défaut est strictement limitée aux dispositions ci-dessus qui tiennent lieu et place de toute autre garantie

Le délai de livraison étant donné à titre simplement indicatif, en cas de retard, il ne pourra être réclamé d'indemnité

En aucun cas la société TEKNI-LED n'est responsable des dommages indirects, prévisibles ou non, tels que perte de profit, de production, de chiffre d'affaires, privation de jouissance, de revenu ou préjudice commercial. La responsabilité contractuelle au titre de tout autre dommage dans le cadre d'une commande, ne pourra en aucune circonstance excéder cinquante (50) % du montant des paiements (hors taxes) reçus par la société TEKNI-LED au titre des produits en cause

## 10. Propriété Intellectuelle - Confidentialité

La société TEKNI-LED conserve intégralement l'ensemble des droits de propriété intellectuelle de ses projets, études et documents de toute nature. En cas de communication, quel qu'en soit le support, ces éléments doivent lui être restitués à première demande. La technologie et le savoir-faire, breveté ou non, ainsi que tous les droits de propriété intellectuelle relatifs (i) aux produits, (ii) aux systèmes d'éclairage et (iii) aux prestations, restent la propriété pleine et entière de la société TEKNI-LED ou de ses ayants droit. Seul est concédé à l'acheteur et à ses propres clients, à titre non exclusif, un droit d'usage

Les informations confidentielles de la société TEKNI-LED ne doivent en aucun cas être transmises à un tiers au contrat

## 11. Réexportation - Exportation, Export control

L'exportation ou la réexportation des produits la société TEKNI-LED hors des pays faisant partie de l'Union Européenne est interdite sauf accord préalable écrit du responsable de contrôle des exportations de la société TEKNI-LED.

Pour formuler cette demande, l'Acheteur a l'obligation de fournir spontanément par écrit à la commande le lieu de destination finale et d'utilisation des produits, ainsi que le nom du client final

L'Acheteur s'engage à respecter la réglementation nationale et internationale en matière de contrôle des exportations.

En toute hypothèse, la société TEKNI-LED se réserve la faculté de suspendre et/ou résilier toute commande ou contrat en cours en cas de suspicion d'infraction à ces règles.

## 12. Force Majeure

La survenance d'un cas de forte majeure a pour effet de suspendre l'exécution des obligations de la société TEKNI-LED. Il en est notamment ainsi en cas de grève totale ou partielle entravant le fonctionnement de la société TEKNI-LED ou de l'un de ses fournisseurs ou sous-traitants ou transporteurs comme en cas d'interruption des moyens de communication ou de l'énergie ou en cas d'embargo

## 13. Attribution de compétence

Tout litige, quelle qu'en soit la nature ou la cause, sera soumis au tribunal compétent de la juridiction de VIENNE, même en cas de pluralité de défendeurs ou d'appel en garantie. Le droit français est applicable

# GENERAL CONDITIONS OF SALE

## 1. Offers and Estimate

At any time and without advance notice, the information concerned catalogs, notes or tables, can be modified because of the evolution of the technique or the economic conditions. The validity of the offers and the estimate of the company TEKNILED is limited to 1 month.

## 2. Price

The applicable prices are the ones mentioned in tables, offer or current estimate in the date of the signing of the order. The indicated prices are always exclusive of tax. They do not take into account for the lamps of the incidence of the costs selling obligations(bonds) promulgated by the decree n°2005-829 of July 20th, 2005 concerning the waste of Electric and electronic Equipments (EEE). The sale prices of the EEE are thus subject to revision in the course of the year.

## 3. Order

Any order takes the immediate, full and whole acceptance, without reserve of no kind, by the Buyer of the present terms of sale and the renunciation of its part of its own general conditions of purchase. The present terms of sale so establish(constitute), the only ones, the law of the parts for the execution of the order and it with the exception of quite other document whatever it is for the exception however, where necessary, of agreed particular conditions unanimously in writing.

The TEKNILED company reserves the right to bring without advance notice any modifications to its products without having for all that the obligation to modify in the same way the already delivered products or remaining to deliver.

If products were already sent, no cancellation of command(order) is taken into account. For all other products, the Buyer has the faculty to cancel his order)without penalty subject to notifying his decision in writing to the company TEKNI-LED for a maximal deadline of three ( 3 ) days ( T+3) as from the day of the signing of his order ( T ). In case of disregard of this advance notice, no cancellation of order is taken into account.

The Buyer having the knowledge of the custom for which he intends products as well as their conditions of use and, besides, catalogs and specification sheets of the company TEKNI-LED not being able to be exhaustive considers held in particular by the variety of the cases of use and of the big distribution of products, the Buyer recognizes that it is up to him(her) before its order to verify, only or with his own customers, the adequacy of products to the custom that he intends to make it.

## 4. Deliveries

The orders can be executed in one or several deliveries. The delivery deadlines are given as a rough guide.

### a) Packaging

Except particular request chargeable to the Buyer, the packaging of products is standard and function of their natures and the usual mode of transport.

### b) Transport

Our shipments benefit from postage and packing paid for any unitarian order to be delivered in Metropolitan France, of at least 400 euro except VAT. For any order lower than this fixed threshold, a participation corresponding to a share of the expenses of reconditioning will be charged. This amount, dependent on the weight of the shipping amounts to approximately 15 euro except the VAT.

Products travel at the risks and the dangers of the buyer to whom it is up to verify the shipments on arrival whatever is the place of delivery, to state possible reserves and to exercise the complaints with the last carrier by LRAR in 3 working days following the delivery, even if the shipping was made French. Transport, postage and packing paid, always understand unloading by the addressee, the driver who can not operate only. It is up to the Buyer to communicate with order or at the latest 10 days before the delivery, the exact and precise address of the place of delivery as well as the particular constraints which can exist, such the schedules of reception, the underground delivery or in floor, the limitation of size or weight. The Buyer will have to gather the conditions necessary for the reception and for the unloading of products by taking into account their specificities, in particular for the products of big length. Very fresh additional of transport said about the Buyer (for example in case of misdirection of delivery, absence of the addressee or the information relative to the insufficient particular constraints) will automatically be charged to him in the real cost. The Buyer will have to organize the reception of products in particular in case of construction site. Any return in case of impossibility of delivery is at his expense including the expenses of storage and new delivery.

### c) Complaint

To be taken into account, any complaint touching the nature, the type, the characteristics, the delivery notes and the visible quality of products must be indicated to us in writing with acknowledgement of receipt within 3 days as from the delivery.

## 5. Invoicing - Payments

The delivery even partial establishes the generative fact of the invoicing the payment of which is made according to terms of payment indicated below.

The payment is made in the place mentioned on the invoice. The Buyer is filled(performed) with his obligation for payment when the due sum is effectively taken by the company

TEKNI-LED, the simple delivery of the title of payment being insufficient. The Buyer can never proceed to compensations whatever is the reason. Any contesting of an invoice or credit note is to be made in 8 days of its reception. Credit notes are compensated in reciprocity of term.

The payment time of invoices is fixed in agreement with the customer. The invoice mentions the date of payment. In case of pre-payment, no discount is granted.

Delay of payment:

Any delay in payment with regard to the date of payment gives rise by rights to a penalty of delay calculated by application in the sums remaining due of a rate equal to the interest rate applied by the ECB(EUROPEAN CENTRAL BANK) to its most recent operation of refinancing increased by seven points of percentage without that this penalty damages the payability of the debt. The penalties of delay will be payable in reception of the opinion(notice) informing the buyer that they are carried in his debit. In case of contesting or of partial execution of the contract, the payment remains due on the part of the contract disputed or partially executed. The TEKNILED company will also have the faculty to declare resolved by rights the sale of all or any of the products the price of which was not completely paid.

## 6. Property reserve

The TEKNI-LED company keeps the property of the materials sold up to the effective payment of the completeness of the price in main thing and accessories. The non-payment of the one some of the terms can pull the demand of these materials. The Buyer assumes, nevertheless, as from the delivery, the risks of loss or deterioration of these materials as well as the responsibility of the damage which they could cause. No dispensation in this clause can be accepted. The Buyer will not have to distort or delete the signs of identification of these materials and their packagings, the check of which they authorize at any time in their stocks.

## 7. Returns

Except the attributable case of fault or error to the company TEKNI-LED:

- No return of product made To order is accepted.

For products Available, any return is subordinated (i) to the following cumulative conditions:

- The amount of the concerned products is equal or upper to 150 euro exclusive of tax,

- Products are in perfect state in their original packing,

- Products are held, by the Buyer, the arrangement(measure) of the company TEKNILED, in its premises of Vienna after agreement of resumption sent to the buyer by the company TEKNI-LED

And (ii) in a written preliminary acceptance of the company TEKNI-LED

The amount of the credit note corresponding to the resumed(taken back) products is limited to 70 % of their charged amount (exclusive of tax).

## 8. Guarantee

a) The TEKNI-LED company guarantees, during a period of 12 months as from delivery date, the conformity of products with the specifications of the company TEKNILED and with the state of the technical knowledge of moment. Consequently, any vice of functioning resulting from a fault of conception, from material or from manufacturing gives the right, for the reasonable deadline(extension) and in the choice of the company TEKNI-LED, in the exchange or in the repair of the defective recognized products.

b) The cost and the risks of transport of products concerned as well as the expenses of dismantling and reassembly are chargeable to the Buyer. The expenses of spot repair (staff, stay and material) are chargeable to the Buyer.

c) The guarantee does not cover the imperfections which would result from the disregard of the prescriptions of installation, from use and from maintenance or from the disregard of one or several applicable standards or from the state of the art, from a cause foreign to the product (bad electric installation, surge, lightning etc), from any abnormal usage or from any modification or intervention of the Buyer or the third party. The guarantee is not applicable to the normal wear resulting from physical characteristics inherent to the lamps the performances of which are a function of the time of use. Besides, the end of natural life of a product during the extension of guarantee, is not a nonconformity and does not thus benefit from terms of the present article. The guarantee does not apply in case of imperfection resulting from instructions given by the Buyer to the company TEKNI-LED.

d) To benefit from the guarantee, the buyer owes :

- Inform in writing the TEKNI-LED company of the defects which he imputes to the product from demonstration of these defects and at the latest within 1 month

- Supply a detailed description of the advanced defect and the conditions of use of products as well as, at request of the company TEKNI-LED, the samples.

- Refrain, except agreement written by the company TEKNI-LED, to make himself or to make make, the repair;

- Restore, at request of the company TEKNI-LED, products replaced in conformance with the guarantee.

The Guarantee is applicable - directly and only - To the advantage of the Buyer of the company TEKNI-LED and does not extend to the retailers, the agents or the other representatives of the Buyer nor to his own customers.

In case of excessive request of application of the guarantee,

the TEKNI-LED company saves itself the faculty to charge expenses incurred to the Buyer.

The guarantee does not apply to the installations intended for military, aeronautical or medical usage. In these 3 sectors a prior authorization must be required.

Products replaced in conformance with the present guarantee are guaranteed for duration themselves remaining to run in conformance with the initial guarantee. The programming of a system of piloting of Lighting is under the responsibility of customer and exclusive of any guarantee. Any service of technical support on behalf of the company TEKNI-LED is the object of an estimate and an invoicing to the customer.

## 9. Responsibility

The responsibility of the company TEKNILED relative to any complaint in conformance with the guarantee and to any defect is strictly limited to capacities above which hold place and place of quite other guarantee.

The delivery deadline given in simply indicative title, in case of delay, he cannot be demanded by compensation.

On no account the TEKNI-LED company is responsible for consequential, predictable damage or not, such as loss of profit, production, turnover, hardship of enjoyment, income or commercial damage. The contractual liability in conformance with quite other damage within the framework of a order, can exceed no in no event fifty (50) % of the amount of payments ( exclusive of tax ) received by the company TEKNILED in conformance with products in cause.

## 10. Intellectual property - Confidentiality

The TEKNILED company keeps entirely all the intellectual property rights of its projects, studies and documents of all kinds. In case of communication, whatever is the support, these elements must be restored to him in first request. The technology and the know-how, the patentee or not, as well as all the relative intellectual property rights (i) in products, ii) in lighting systems and iii) in the services, remain the full and whole property of the company TEKNILED or his legal successors. Only is granted to the buyer and to his own customers, to the not exclusive title, a right of user.

The confidential information of the company TEKNILED must be passed on on no account in a third party to the contract.

## 11. Re-exportation - Export, control Export

The export or the re-exportation of products of the TEKNI-LED company outside countries being a member of the European Union is forbidden except preliminary agreement written by the person in charge of control of the exports of the company TEKNI-LED.

To formulate this request, the Buyer has the obligation(bond) to supply spontaneously in writing with order the place of final destination and use of products, as well as the name of the final customer.

The Buyer makes a commitment to respect the national and international regulations in control of the exports

In any event, the TEKNI-LED company saves itself the faculty to suspend and/or to cancel any order) current contract in case of suspicion of breach of these rules.

## 12. Force majeure

The emergence of a case of strong adult has the effect of suspending the execution of the obligations(bonds) of the company TEKNILED. He is there in particular so in case of all-out or partial strike hindering the functioning of the company TEKNI-LED or one of his suppliers or subcontractors or carriers as in case of interruption of the means of communication or the energy or in case of embargo.

## 13. Attribution) of competence

Any dispute, whatever is the nature or the cause, will be subjected to the competent court of the jurisdiction of VIENNA, even in case of plurality of defendants or appeal)in guarantee. The French law is applicable.